

BRL-K17301

Datum jjjj-mm-dd

bindendverklaring

Evaluation Guideline

for the Kiwa product certificate for piping systems of PVC for
the transport of drinking water and raw water

Preface

This evaluation guideline has been accepted by the Kiwa Board of Experts Water Cycle (CWK), in which all relevant parties in the field of piping systems of PVC for the transport of drinking water and raw water are represented. The Board of Experts also supervises the certification activities and where necessary requires the evaluation guideline to be revised. All references to Board of Experts in this evaluation guideline pertain to the above mentioned Board of Experts.

This evaluation guideline will be used by Kiwa in conjunction with the Kiwa Regulations for Certification.

Kiwa Nederland B.V.

Sir Winston Churchillaan 273
Postbus 70
2280 AB RIJSWIJK
The Netherlands

Tel. +31 88 998 44 00
Fax +31 88 998 44 20
info@kiwa.nl
www.kiwa.nl

© 2020 Kiwa N.V.

All rights reserved. No part of this report may be reproduced, stored in a database or retrieval system, or published, in any form or in any way, electronically, mechanically, by print, photoprint, microfilm or any other means without prior written permission from the publisher.

The use of this evaluation guideline by third parties, for any purpose whatsoever, is only allowed after a written agreement is made with Kiwa to this end.

Validation

This evaluation guideline has been validated by the Director Certification and Inspection of Kiwa on

Date

Contents

1	Introduction	6
1.1	General	6
1.2	Field of application	6
1.3	Acceptance of test reports provided by the supplier	6
1.4	Quality declaration	6
2	Terms and definitions	7
2.1	Definitions	7
2.2	Abbreviations, terms and definitions	8
3	Procedure for granting a product certificate	11
3.1	Initial investigation	11
3.2	Granting the product certificate	11
3.3	Investigation into the product and/or performance requirements	11
3.4	Production process assessment	11
3.5	Contract assessment	11
4	General requirements and test methods	12
4.1	General	12
4.2	Regulatory requirements	12
4.2.1	Requirements to avoid deterioration of the quality of drinking water	12
4.2.2	Hygienic treatment of products in contact with drinking water	12
4.2.3	Protection products during storage and transport	13
4.3	Material	13
4.3.1	General requirements for compounds or formulations	13
4.3.2	VCM content in material	13
4.3.3	Density	13
4.3.4	K value	13
4.3.5	Classification and verification of the material	13
4.4	Rubber sealings	14
4.5	Adhesive sealings	14
4.6	General characteristics of the products	14
4.6.1	Appearance	14
4.6.2	Colour	15
4.6.3	Opacity	15
4.7	Changes	15
4.8	Requirements for joints	15
4.8.1	Fittings with elastomeric sealing rings	15
4.8.2	Long-term leaktightness under internal pressure of PVC-U solvent cemented joints	15
4.8.3	Saddles of PVC-U	16
5	Product requirements and test methods for PVC pipes	18
5.1	General	18
5.2	PVC-U Pipes	18

5.2.1	Material	18
5.2.2	General characteristics	18
5.2.3	Geometrical characteristics	19
5.2.4	Classification and selection of the pipes	20
5.2.5	Mechanical characteristics	20
5.2.6	Physical characteristics	20
5.2.7	Marking of PVC-U drinking water pipes	21
5.3	PVC-O Pipes (biaxial oriented PVC-U)	21
5.3.1	General	21
5.3.2	Material	21
5.3.3	General characteristics	22
5.3.4	Geometrical characteristics	22
5.3.5	Selection of pipes	22
5.3.6	Mechanical characteristics	22
5.3.7	Physical characteristics	23
5.3.8	Marking of PVC-O drinking water pipes	23
6	Product requirements and test methods for PVC fittings	24
6.1	General	24
6.2	Fittings with elastomeric sealing rings	24
6.2.1	Rubber	24
6.2.2	Material	24
6.2.3	General characteristics	24
6.2.4	Geometrical characteristics	24
6.2.5	Mechanical characteristics	25
6.2.6	Physical characteristics	26
6.2.7	Marking of elastimeric ring seal fittings	27
6.3	Fittings for solvent cemented joint	28
6.3.1	Adhesive instruction	28
6.3.2	Material	28
6.3.3	General characteristics	28
6.3.4	Geometrical characteristics	28
6.3.5	Mechanical characteristics	29
6.3.6	Physical characteristics	30
6.3.7	Marking of PVC-U and PVC-UH fittings voor solvent cementing joints	31
6.4	Bends made from pipe	31
6.4.1	General	31
6.4.2	Geometrical characteristics	31
6.4.3	Bend ends	32
6.4.4	Bends with sockets for solvent cementing	32
6.4.5	Mechanical characteristics	32
6.4.6	Markings bends made from PVC-U drinking water pipes	33
7	Product requirements and test methods for special fittings	34
7.1	General	34
7.2	Saddles of PVC-U	34
7.2.1	General	34
7.2.2	Material	34
7.2.3	Elastomeric rings	34
7.2.4	General characteristics	34
7.2.5	Construction and design	34
7.2.6	Geometrical characteristics	35
7.2.7	Screw-thread in the saddles	35
7.2.8	Mechanical characteristics	36
7.2.9	Physical characteristics	38
7.2.10	Markings of saddles for PVC-U drinking water pipes	38

7.3	End-load-bearing double-sockets of PE and PVC	39
7.3.1	General	39
7.3.2	Material	39
7.3.3	Elastomeric sealing rings	39
7.3.4	Adhesives and cleaning products	39
7.3.5	Locking device and its components	39
7.3.6	General characteristics	39
7.3.7	Geometrical characteristics	40
7.3.8	Mechanical characteristics	41
7.3.9	Physical characteristics	41
7.3.10	Joint requirements end-load-bearing double socket couplers	41
7.3.11	Marking end-load-bearing fittings of PE and PVC-U for drinking water pipes	41
7.4	Injection moulded PVC fittings with flange connections	42
7.4.1	General	42
7.4.2	Material	42
7.4.3	Rubber	42
7.4.4	General characteristics	42
7.4.5	Geometrical characteristics	43
7.4.6	Mechanical characteristics	43
7.4.7	Joint requirements	44
7.4.8	Markings of injection moulded PVC-U fittings with flange connections voor drinking water pipes	45
8	Requirements in respect of the quality system	47
8.1	Manager of the quality system	47
8.2	Internal quality control/quality plan	47
8.3	Control of test and measuring equipment	47
8.4	Procedures and working instructions	47
9	Summary of tests and inspections	48
9.1	Test matrix for PVC-U pipes	49
9.2	Test matrix for PVC-O pipes	50
9.3	Test matrix for fittings with elastomeric sealing rings	51
9.4	Test matrix of fittings for solvent cementing	52
9.5	Test matrix bends made from pipe	53
9.6	Test matrix saddles of PVC-U	54
9.7	Test matrix end-load-bearing double sockets of PE and PVC	55
9.8	Test matrix for injection moulded PVC fittings with flange connections	56
9.9	Inspection of the quality system of the supplier	56
10	Agreements on the implementation of certification	57
10.1	General	57
10.2	Certification staff	57
10.2.1	Qualification requirements	57
10.2.2	Qualification	58
10.3	Report initial investigation	58
10.4	Decision for granting the certificate	59
10.5	Layout of quality declaration	59
10.6	Nature and frequency of third party audits	59

10.7	Non conformities	59
10.8	Report to the Board of Experts	60
10.9	Interpretation of requirements	60
11	Titles of standards	61
11.1	Public law rules	61
11.2	Standards / normative documents	61
I	Model certificate (example)	64
II	Model IQC-scheme (example)	65
III	Maximum allowable operating pressure (PFA) and de-rating factors	66
IV	Design coefficient	67
V	Guidance for prevention of contamination during transport and storage of new products	68
	Protection of the products during storage and transport	68
	Requirements for the protection	68
	Capabilities to protect the product:	69
VI	Comparison of standards (informative)	70

1 Introduction

1.1 General

This evaluation guideline includes all relevant requirements which are employed by Kiwa when dealing with applications for the issue and maintenance of a certificate for products used for piping systems of PVC for the transport of drinking water and raw water.

This guideline replaces the evaluation guideline BRL-K17301, dated 15-09-2017. The certificates issued and based on that guideline will lose their validity at least 2 years after validation of this BRL.

For the performance of its certification work, Kiwa is bound to the requirements as included in NEN-EN-ISO/IEC 17065 "Conformity assessment - Requirements for bodies certifying products, processes and services".

At setting the requirements the uncertainties of the measurements are taken into account. This implies that drawing conclusions whether requirements are fulfilled these uncertainties do not need to be weighted anymore.

1.2 Field of application

The products are intended to be used in piping systems for the transport of drinking water till a temperature of 20 °C which are not exposed to sunlight.

This guideline also applies to unplasticized polyvinylchloride (PVC-U) and oriented polyvinylchloride (PVC-O) piping systems for the transport of drinking water and raw water heated till a temperature of 45 °C. For temperatures between 25 °C and 45 °C a de-rating factor is applicable for the calculation of the maximum permissible working pressure in these piping systems (see annex III).

1.3 Acceptance of test reports provided by the supplier

If the supplier provides reports from test institutions or laboratories to prove that the products meet the requirements of this evaluation guideline, the supplier shall prove that these reports have been drawn up by an institution that complies with the applicable accreditation standards, namely:

- NEN-EN-ISO/IEC 17020 for inspection bodies;
- NEN-EN-ISO/IEC 17021-1 for certification bodies certifying systems;
- NEN-EN-ISO/IEC 17024 for certification bodies certifying persons;
- NEN-EN-ISO/IEC 17025 for laboratories;
- NEN-EN-ISO/IEC 17065 for certification bodies certifying products.

Remark:

This requirement is considered to be fulfilled when a certificate of accreditation can be shown, issued either by the Board of Accreditation (RvA) or by one of the institutions with which an agreement of mutual acceptance has been concluded by the RvA. The accreditation shall refer to the examinations as required in this evaluation guideline. When no certificate of accreditation can be shown, Kiwa shall verify whether the accreditation standard is fulfilled.

1.4 Quality declaration

The quality declaration to be issued by Kiwa is described as a Kiwa product certificate.

A model of the certificate to be issued on the basis of this evaluation guideline has been included for information as Annex I.

2 Terms and definitions

2.1 Definitions

In this evaluation guideline, the following terms and definitions apply:

- **Board of Experts:** the Board of Experts Water Cycle (CWK).
- **Certification mark:** a protected trademark of which the authorization of the use is granted by Kiwa, to the supplier whose products can be considered to comply on delivery with the applicable requirements .
- **Drinking water:** water intended or partly intended for drinking, cooking or food preparation or other domestic purposes, but does not include hot water, and is made available by pipeline to consumers or other customers.
- **Evaluation Guideline (BRL):** the agreements made within the Board of Experts on the subject of certification.
- **Tap water:** (origin NEN 1006): water intended for drinking, cooking, food preparation or other domestic purposes.
- **Raw water:** water that is used for the production of tap water (drinking water).
- **Installation:** configuration consisting the pipe work, fittings and appliances;
- **Inspection tests:** tests carried out after the certificate has been granted in order to ascertain whether the certified products continue to meet the requirements recorded in the evaluation guideline.
- **IQC scheme (IQCS):** a description of the quality inspections carried out by the supplier as part of his quality system.
- **Initial investigation:** tests in order to ascertain that all the requirements recorded in the evaluation guideline are met.
- **Private Label Certificate:** A certificate that only pertains to products that are also included in the certificate of a supplier that has been certified by Kiwa, the only difference being that the products and product information of the private label holder bear a brand name that belongs to the private label holder.
- **Product certificate:** a document in which Kiwa declares that a product may, on delivery, be deemed to comply with the product specification recorded in the product certificate.
- **Product requirements:** requirements made specific by means of measures or figures, focussing on (identifiable) characteristics of products and containing a limiting value to be achieved, which can be calculated or measured in an unequivocal manner.
- **Supplier:** the party that is responsible for ensuring that the products meet and continue to meet the requirements on which the certification is based.
- **Special fitting:** fitting with an extra function.

- **Gluing, solvent cementing** : the process wherein the pipe and the fitting or a fitting and another fitting are connected to each other using a solvent-containing adhesive.
- **Spigot end fitting**: fitting where the outer diameter of the spigot end is equal to the nominal outside diameter d_n of the corresponding pipe.
- **End-load bearing joint**: joint that can resist axial loads without external mechanical support.
- **Non-end-load bearing joint**: joint that cannot resist an axial load without external mechanical support.

2.2 Abbreviations, terms and definitions

In this evaluation guideline the terms and definitions listed in NEN-EN-ISO 1452: 1, 2, 3, 4 and 5 and listed in table 1 apply.

Table 1 – Abbreviations, terms and definitions which are applicable to this BRL.

Abbreviation	Term	Definition
λ_a	Axial orientation factor	Factor related to the stretch ratio used in the orientation processing in axial direction
λ_c	Circumferential orientation factor	Factor related to the stretch ratio used in the orientation processing in circumferential direction
d_n	Nominal diameter	Specified diameter assigned to a nominal size.
	<p>Note 1: According to NEN-EN-ISO 1452, the nominal (outside) diameter of a thermoplastics pipe or a spigot, is equal to its minimum mean outside diameter, $d_{em,min}$.</p> <p>Note 2: The nominal (inside) diameter of the socket of a fitting, pipe, valve or of ancillary equipment is equal to the nominal (outside) diameter of the connecting pipe for which they are designed.</p> <p>Note 3: The nominal diameter is expressed in millimetres.</p>	
d_e	Outside diameter at any point	Value of the measurement of the outside diameter through its cross-section at any point of a pipe, rounded up to the nearest 0,1 mm
d_{em}	Mean outside diameter	Value of the measurement of the outer circumference of a pipe or spigot end of a fitting in any cross-section, divided by π ($\approx 3,142$), rounded up to the nearest 0,1 mm
$d_{em,min}$	Minimum outside diameter	The minimum value of the mean outside diameter as specified in this BRL. The value is equal to the nominal outside diameter d_n and is expressed in mm
$d_{em,max}$	Maximum outside diameter	The maximum value of the mean outside diameter as specified in this BRL. The value is equal to the nominal outside diameter d_n and is expressed in mm
d_i	Inside diameter at any point	Value of the measurement of the inside diameter through its cross-section at any

		point of a pipe, rounded up to the nearest 0,1 mm
d _{im}	Mean inside diameter	Mean inside diameter determined according to NEN-EN-ISO 3126: clause 5.3.4
d _{im,min}	Minimum inside diameter	The minimum value of the mean inside diameter as specified in this BRL. The value is expressed in mm
d _{im,max}	Maximum inside diameter	The maximum value of the mean inside diameter as specified in this BRL. The value is expressed in mm
e	Wall thickness	Value of the wall thickness of the pipe or fitting.
e _y	Wall thickness at any point	Value of the measurement of the wall thickness at any point around the circumference of a pipe or fitting, rounded up to the nearest 0,1
e _n	Nominal wall thickness	The wall thickness according to the corresponding table in ISO 4064 and equal to the minimum allowable wall thickness at any point, e _{y,min}
e _m	Mean wall thickness	Arithmetical mean of at least four measurements of the wall thickness, regularly spaced around the circumference and in the same cross-section of a component, including the measured minimum and the measured maximum values of the wall thickness in that cross-section. De value is rounded up to the nearest 0,1 mm.
	Tolerance out-of-roundness	d _{em,max} – d _{em,min}
	Measured out-of-roundness	Difference between the measured maximum and the measured minimum outside diameter in the same cross-section of a pipe.
	Tolerance	Permitted variation of the specified value of a quantity, expressed as the difference between the permitted maximum and the permitted minimum value
SDR	Standard dimension ratio	Numerical designation of a pipe series which is a convenient round number approximately equal to the dimension ratio of the nominal outside diameter, d _n , and the nominal wall thickness, e _n
	Note: According to ISO 4065, the standard dimension ratio, SDR, and the pipe series S are related as given in the following equation: SDR = 2 S + 1	
S	Pipe series	Dimensionless number for pipe designation.
	Note: The pipe series S is related to a given pipe geometry as given in the following equation: $S = \frac{SDR - 1}{2} = \frac{d_n - e_n}{2 \times e_n}$	
OLPL	Lower prediction limit	Quantity which can be considered as a material property, representing the 97,5 % lower confidence limit of the

		predicted long-term hydrostatic strength at 20 °C for 50 years with internal water pressure.
	Note: σ_{LPL} is expressed in megapascals (MPa).	
MRS	Minimum required strength	Value of σ_{LPL} , rounded to the next lower value of the R10 series when σ_{LPL} is below 10 MPa, or to the next lower value of the R20 series when σ_{LPL} is 10 MPa or greater.
	Note: The R10 and R20 series are the basic series of preferred numbers conforming to ISO 3 and ISO 497.	
C	Design coefficient	Overall coefficient with a value greater than 1,00, which takes into consideration service conditions as well as properties of the components of a piping system other than those represented in the lower predictive limit (LPL)
σ_s	Design stress	Allowable stress for a given application at 20 °C.
	<p>Note 1: It is derived from the MRS by dividing it by the coefficient, C, using the following equation:</p> $\sigma_s = \frac{MRS}{C}$ <p>Note 2: Design stress is expressed in megapascals (MPa).</p>	
PN	Nominal pressure	Numerical designation used for reference purposes related to the mechanical characteristics of a component of a piping system
	<p>Note 1: A pressure in bar, numerically equal to PN is identical to the (maximum) allowable working pressure (PFA), when both pressures are taken at 20 °C.</p> <p>Note 2: For plastics piping systems, it corresponds to the allowable operating pressure, in bar 1), conveying water at 20 °C during 50 years, as given in the following equation:</p> $PN = \frac{20 \times MRS}{C \times (SDR - 1)}$ <p>MRS is expressed in MPa PN is expressed in bars</p>	
PFA	(Maximum) allowable operating pressure	Maximum hydrostatic pressure which a component is capable of withstanding continuously in service (excluding surge).
	<p>Note: For water temperatures up to and including 25 °C: PFA = PN</p> <p>For water temperatures above 25 °C: PFA: PFA = f_T × PN where f_T is the derating factor depending on water temperature; PN is the nominal pressure.</p> <p>In cases where a further derating factor for application is required: PFA = f_A × f_T × PN, where f_A is the factor depending on the application.</p>	

3 Procedure for granting a product certificate

3.1 Initial investigation

The initial investigation to be performed are based on the (product) requirements as contained in this evaluation guideline, including the test methods, and comprises, the following:

- type testing to determine whether the products comply with the product and/or functional requirements;
- production process assessment;
- assessment of the quality system and the IQC-scheme;
- assessment on the presence and functioning of the remaining procedures.

3.2 Granting the product certificate

After finishing the initial investigation, the results are presented to the Decision maker (see 10.2) deciding on granting the certificate. This person evaluates the results and decides whether the certificate can be granted or if additional data and/or tests are necessary.

3.3 Investigation into the product and/or performance requirements

Kiwa will investigate the to be certified products against the certification requirements as stated in the certification requirements.

The necessary samples will be drawn by or on behalf of Kiwa.

3.4 Production process assessment

When assessing the production process, it is investigated whether the producer is capable of continuously producing products that meet the certification requirements. The evaluation of the production process takes place during the ongoing work at the producer.

The assessment also includes at least:

- The quality of raw materials, half-finished products and end products;
- Internal transport and storage.

3.5 Contract assessment

If the supplier is not the producer of the products to be certified, Kiwa will assess the agreement between the supplier and the producer.

This written agreement, which is available for Kiwa, includes at least:

Accreditation bodies, scheme managers and Kiwa will be given the opportunity to observe the certification activities carried out by Kiwa or on behalf of Kiwa at the producer.

4 General requirements and test methods

4.1 General

This chapter contains the requirements the piping systems for the transport of drinking water and raw water have to fulfil, as well as the test methods to determine if the requirements are met.

The product requirements and test methods for components of PVC-U are based on NEN-EN-ISO 1452, parts 1, 2, 3, and 5. De product requirements and test methods for PVC-O pipes are based on NEN-EN 17176, parts 1 and 2. The evaluation guideline contains additional requirements and test methods set by the Board of Experts.

For the complete system of pipes and fittings applies that the working pressure is equal or lower than the nominal pressure of the component with the lowest nominal pressure. In practice the working pressure shall be less than the nominal pressure.

For tests carried out at the production location, a temperature between 15°C and 30°C is allowed.

Guidance for design, installation and maintenance is given in:

- for outside buildings NEN-EN 805
- for inside buildings NEN-EN 806

4.2 Regulatory requirements

4.2.1 *Requirements to avoid deterioration of the quality of drinking water*

Products and materials which (may) come into contact with drinking water or warm tap water, shall not release substances in quantities which can be harmful to the health of the consumer, or negatively affect the quality of the drinking water.

Therefore, the products or materials shall meet toxicological, microbiological and organoleptic requirements as laid down in the currently applicable "Ministerial Regulation materials and chemicals drinking water and warm tap water supply", (published in the Government Gazette). Consequently, the procedure for obtaining a recognised quality declaration, as specified in the currently effective Regulation, has to be concluded with positive results.

Products and materials with a quality declaration¹, e.g. issued by a foreign certification institute, are allowed to be used in the Netherlands, provided that the Minister has declared this quality declaration equivalent to the quality declaration as meant in the Regulation.

4.2.2 *Hygienic treatment of products in contact with drinking water*

The supplier must have a procedure in place that protects the products in such way, that the hygiene is ensured during storage and transport.

In addition, the supplier shall inform the customer about the handling of products delivered under the certificate, which come into contact with drinking water and warm tap water, from arriving at the construction site through to the realization and

¹ A quality declaration issued by an independent certification institute in another member state of the European Community or another state party to the agreement to the European Economic Area, is equivalent to a recognized quality declaration, to the extent that, to the judgment of the Minister of the first mentioned quality declaration, is fulfilled the at least equivalent requirements as meant in the Regulation materials and chemicals drinking water- and warm tap water supply.

commissioning. The primary reason for providing this the information is to contribute to the awareness of the importance of hygienic work as a 'prevention measure'.

4.2.3 Protection products during storage and transport

For the purpose of hygienic work, products shall be protected against contamination. It concerns the surfaces of the product that in the application come into contact with drinking water. More information is given in see annex V.

4.3 Material

4.3.1 General requirements for compounds or formulations

The pipes, fittings and valves must be manufactured from unplasticized polyvinyl chloride (PVC-U) to which only those additives may be added which are strictly required for:

- the manufacturing of the raw material;
- the production of pipes with the required characteristics and the desired colour.

None of these additives may be separately or together be present in the raw material in such amounts that risk with regard to toxicity may occur, problems of organic nature, grow of bacterium or that the ability for gluing of the pipes is negatively affected. The same applies in respect of the chemical and physical properties of the products.

The supplier is allowed to use broken, earlier processed material for the manufacturing of the pipes, provided that the material originates from own production. The supplier shall demonstrate that the characteristics of the products manufactured from reprocessed material fulfil the requirements of this evaluation guideline. The supplier shall keep records of the reprocessed material in such a way that the pipes concerned are recognisable for the certification body.

4.3.2 VCM content in material

Shall be conform NEN-EN-ISO 1452-1:2009 Article 4.1.

4.3.3 Density

The density of the material shall be determined according to NEN-EN-ISO 1183-1. The material shall have a density greater than or equal to 1350 kg/m³ and smaller or equal to 1460 kg/m³.

4.3.4 K value

For the K value of the raw material for PVC-U pipes see 5.2.1.2 and for PVC-O pipes see 5.3.2.1.

The K value of the raw material for the production of fittings shall be at least 55,0 when determined according to NEN-EN-ISO 13229.

4.3.5 Classification and verification of the material

4.3.5.1 Classification of compounds in pipe form

Compounds or formulations shall be designated according to NEN-EN-ISO 1452-1:2009, clause 4.4.1.

4.3.5.2 Verification of compounds in pipe form

Compounds or formulations shall be verified according to NEN-EN-ISO 1452-1:2009, clause 4.4.2.

Examples of the test parameters for the verification tests are listed in NEN-EN-ISO 1452-1:2009, table 2.

For the convenience of the reader in this evaluation guideline also a table with examples of test parameters is listed (table 2) with additional values for an exposure time of 1 and 10 hours and a temperature of 40 °C.

Table 2 – Examples of test parameters for verification tests

Duration (hours)	Temperature (°C)	Stress, σ, (MPa)
1	20	42,00
10	20	38,31
100	20	35,00
1000	20	31,87
5000	20	29,90
1	40	30,03
10	40	26,53
100	40	23,45
1000	40	20,73
5000	40	19,01
1	60	17,01
10	60	14,25
100	60	11,95
1000	60	10,00
5000	60	8,85

4.3.5.3 *Pipe material*

See requirement in article 5.2.1.5 for PVC-U pipes and 5.3.2.4 for PVC-O pipes.

4.3.5.4 *Material of fittings*

The fitting material shall have a minimum required strength (MRS) as defined in NEN-EN-ISO 1452-1:2009, clause 4.4.1.

The supplier shall confirm the MRS value by testing as described in NEN-EN-ISO 1452-1:2009, clause 4.4.1, clause 4.4.2 or clause 4.4.3, respectively.

The material of the fittings shall be designated as PVC-U or PVC-UH.

Note: for testing, NEN-EN 12107 can be used for guidance.

4.4 **Rubber sealings**

In case rubber sealing elements are present in the joints, the rubber elements shall meet the requirements of Kiwa BRL-K17504.

4.5 **Adhesive sealings**

In case adhesive joints are applied, the adhesive shall meet the requirements of Kiwa BRL-K525.

4.6 **General characteristics of the products**

Characteristics of the products

4.6.1 **Appearance**

When viewed without magnification, the internal and external surfaces shall be smooth, clean and free from scoring, cavities and other surface defects. The ends shall be smooth and perpendicular in relation to the pipe axis.

4.6.2 Colour

The colour of the products shall be grey, blue, cream or white with blue strips. The cream and white with blue strips colour is not allowed for pipes intended for aboveground application.

4.6.3 Opacity

Products intended for aboveground application must be coloured in such a way that the walls do not let through more than 0,2 % light when tested in accordance with NEN-EN-ISO 7686.

4.7 Changes

After significant change to the product or the production process it is necessary to determine if the products still meet the requirements.

All intended changes by the supplier shall be notified in writing to the certification body. The certification body shall determine what constitutes a significant change. Once it is determined that the products with the proposed change meet the requirements of this BRL, the change may be implemented in the production process of the suppliers.

As guidance with changes of the product the following documents shall be used:

- NPR-CEN/TS 1452-7 for PVC-U products
- CEN/TS 17176-7 for PVC-O products

4.8 Requirements for joints

4.8.1 Fittings with elastomeric sealing rings

4.8.1.1 Leaktightness under internal pressure and with angular deflection

The leaktightness under internal pressure and with an angular deflection shall be determined according to NEN-EN-ISO 13845 taking into account the following additions / modifications:

- Number of test pieces is 3.
- Double sockets or the fittings shall meet the requirements of clause 6.2
- Pipes shall meet the requirements of clause 5.2 or clause 5.3.

The joint fulfils the requirements when during the test no leakage is detected.

4.8.1.2 Leaktightness under negative pressure

The leaktightness under negative pressure shall be determined according to NEN-EN-ISO 13844 taking into account the following additions / modifications:

- Number of test pieces is 3.
- Double sockets or the fittings shall meet the requirements of clause 6.2
- Pipes shall meet the requirements of clause 5.2 or clause 5.3.

Note: Pressure: 1 bar is 0,1 MPa. In this document with test pressure an over pressure is meant.

The joint fulfils the requirements when during the prescribed test duration, the pressure change at the set pressure of -0,1 bar and the set pressure of -0,8 bar is less than 0,05 bar.

4.8.2 Long-term leaktightness under internal pressure of PVC-U solvent cemented joints

The long-term leaktightness under internal pressure shall be determined according to NEN-EN-ISO 13846 taking into account the following additions / modifications:

- Number of test pieces is 3.
- Pipes shall meet the requirements of clause 5.2 or clause 5.3.
- Fitting shall meet the requirements of clause 6.3.

- The free length of the pipe section is $3 \times d_n$ with a minimum of 250 mm.
- The test is carried out at a temperature of $40^{+3,-1}$ °C.
- Test duration is 1000 hours.
- Test pressure is $1,3 \times PN$.

The solvent cementing takes place in accordance with the instructions of the supplier. The drying time amounts at least 30 days at a temperature of (23 ± 2) °C. In consultation with the supplier another drying time can be agreed upon. Socket-spigot fittings (reducing rings) must be solvent cemented in the same manner.

The joint fulfils the requirements when no leakage nor cracking in the assembly are detected during the test.

4.8.3 Saddles of PVC-U

Test pieces are required which are prepared in accordance with the instructions of the supplier. For the preparation PVC pipes are required which comply with clause 5.2 or clause 5.3. The saddles must comply with clause 7.2.

The pipes shall have the same pressure class as the saddles. The test pieces must be conditioned at least 1 hour before testing at a temperature of 23 ± 2 °C.

4.8.3.1 Leaktightness under internal pressure

The (long-term) leaktightness under internal pressure shall be determined according to NEN-EN-ISO 13846 taking into account the following additions / modifications:

- Number of test pieces is 3.
- The test shall be performed at a temperature of (23 ± 2) °C.
- Test duration is 10 minutes;
- Test pressure is $1,5 \times PN$.

The joint fulfils the requirements when no leakage nor cracking in the assembly are detected during the test.

4.8.3.2 Leaktightness under negative pressure

The leaktightness under vacuum shall be determined according to NEN-EN 12294 taking into account the following additions / modifications:

- Number of test pieces is 3.
- The test shall be carried out at a test temperature of (23 ± 2) °C.
- Internal pressure regime according to figure 2.

The joint fulfils the requirements when during the prescribed test duration, the pressure change at the set pressure of -0,1 bar and the set pressure of -0,8 bar is less than 0,05 bar.

4.8.3.3 Leaktightness under negative pressure and compression of the pipe

The leaktightness under vacuum and compression of the pipe shall be determined according to NEN-EN 12294 taking into account the following additions / modifications:

- Number of test pieces is 1.
- The test shall be carried out at a test temperature of (23 ± 2) °C.
- The test shall be carried out with a negative pressure of -0,5 bar.
- Duration of the test is 10 minutes.
- During the test, the pipe shall be compressed between two flat plates up till 10 % of the nominal diameter of the pipe (see figure 1).

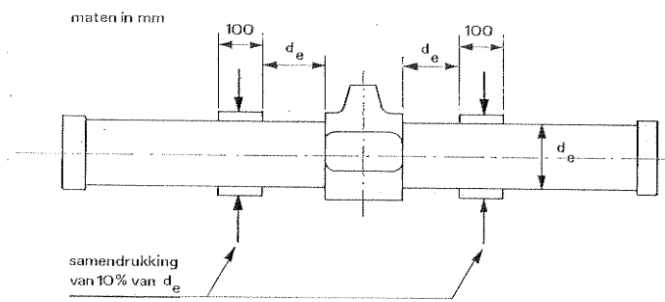

Figure 1 - Test for leaktightness of the pipe under negative pressure and compression of the pipe

The joint fulfils the requirements when during the prescribed test duration, the pressure change at the set pressure of -0,5 bar is less than 0,05 bar.

5 Product requirements and test methods for PVC pipes

5.1 General

This chapter contains the requirements to which PVC pipes for the transport of drinking water have to comply with:

- General requirements see chapter 4.1;
- Toxicological requirements see chapter 4.2;
- Rubber sealings see chapter 4.4;
- Adhesive sealings see chapter 4.5;
- Changes see chapter 4.7;
- Requirements for joints see chapter 4.8;
- For PVC-U pipes see chapter 5.2;
- For PVC-O pipes see chapter 5.3.

5.2 PVC-U Pipes

5.2.1 Material

5.2.1.1 General requirements including VCM content

Shall be conform NEN-EN-ISO 1452-1:2009 Article 4.1.

5.2.1.2 K-value

The K value of the raw material for the production of pipes shall be at least 65,0 when determined according to NEN-EN-ISO 13229.

5.2.1.3 Use of non-virgin material

Shall be conform NEN-EN-ISO 1452-1:2009 Article 4.3, within addition:

- The supplier shall demonstrate that the characteristics of the products manufactured from reprocessed material fulfil the requirements of this evaluation guideline. The supplier shall keep records of the reprocessed material in such a way that the pipes concerned are recognisable for the certification body.

5.2.1.4 Density

Shall be conform NEN-EN-ISO 1452-2:2009 Article 4.2.

5.2.1.5 Classification and verification including MRS

Shall be conform:

- NEN-EN-ISO 1452-1:2019 Article 4.4.1 & Article 4.4.2;
- NEN-EN-ISO 1452-2:2019 Article 4.3.

5.2.2 General characteristics

5.2.2.1 Appearance

Shall be conform NEN-EN-ISO 1452-2:2009 Article 5.1.

5.2.2.2 Colour

Shall be conform 4.6.2.

5.2.2.3 Opacity

Shall be conform NEN-EN-ISO 1452-2:2009 Article 5.3.

5.2.3 Geometrical characteristics

Dimensions shall be measured conform NEN-EN-ISO 1452-2:2009 Article 6.1.

5.2.3.1 Nominal outside diameter and tolerances

Shall be conform NEN-EN-ISO 1452-2:2009 Article 6.2.

5.2.3.2 Mean outside diameter and tolerances

Shall be conform NEN-EN-ISO 1452-2:2009 Article 6.3.

5.2.3.3 Wall thickness and their tolerances

Shall be conform NEN-EN-ISO 1452-2:2009 Article 6.4.

5.2.3.4 Length of pipe

Shall be conform NEN-EN-ISO 1452-2:2009 Article 6.5.

5.2.3.5 Dimensions of pipes with integral sockets for solvent cementing joints

Shall be conform NEN-EN-ISO 1452-2:2009 Article 6.6.1,

within addition:

- Values shall be recorded in the Internal quality control scheme of the supplier.

Note: Values listed in NEN-EN-ISO 1452-2:2009, Article 6.6.1, are mean values.

Values laid down in the IQC scheme of the supplier, could be minimum values.

5.2.3.6 Dimensions of pipes with integral sockets with rubber sealing rings type joints

Shall be conform NEN-EN-ISO 1452-2:2009 Article 6.6.2.

5.2.3.7 Dimensions of pipe ends

Pipes with plain ends intended to be used with elastomeric ring seal sockets shall be chamfered as shown in Figure 2. The tapered portion should be smooth and without damage. The pipe ends shall comply with the requirements listed in table 5.

Table 5 – Dimensions of the tapered end (expressed in mm)

Nominal outside diameter d_n		e_1	l	alpha	
greater than	up and including	min	min	min	max
-	90	0,50 x e_{min}	4	5°	15°
90	110		6		
110	125		7		
125	400		8		
400	-		10		

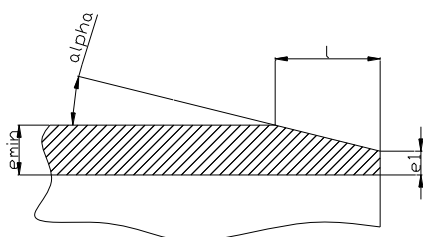

Figure 2 – Chamfer

Pipes with plain ends intended to be used for solvent cement joints shall have all sharp edged removed.

5.2.4 Classification and selection of the pipes

Shall be conform NEN-EN-ISO 1452-2:2009 Article 7.
See annex IV for further details.

5.2.5 Mechanical characteristics

5.2.5.1 Impact strength

Shall be conform NEN-EN-ISO 1452-2:2009 Article 8.1,
within addition:

- EN 744 is replaced by NEN-EN-ISO 3127, and shall be executed according to NEN-EN-ISO 3127;
- The test temperature is (0 ± 2) °C.

5.2.5.2 Resistance to internal pressure

Shall be conform NEN-EN-ISO 1452-2:2009 Article 8.2,
within addition:

- The resistance to internal pressure of pipes shall be determined according to NEN-EN-ISO 1167, all parts.
- Test parameters: Temperature 20°C; Duration 100 hours; See table 7;
- For each combination of temperature and test duration one test pieces is tested; See table 7;
- The test pressure shall be calculated in accordance with NEN-EN-ISO 1167-1:2006, clause 7.2. This means, on the basis of the measured dimensions of the pipe.
- End caps type A or B in accordance with NEN-EN-ISO 1167-1 may be used.
- The type of end cap used during the test has an effect on the test results.
- The applicant can choose which end cap will be used.
- The end caps used during the initial investigation will also be used during inspection tests.

Table 7 – Test parameters for the determination of the resistance to internal pressure

Temperature (°C)	Test duration (hours)	Circumferential stress in pipe wall (MPa)
20	1	42,0
20	100	35,0
60	1000	12,5 ^{a)}

5.2.6 Physical characteristics

When not mentioned otherwise, for the pre-certification tests the number of test pieces is 3.

The number of test pieces required for the for factory production control and process control shall be listed in the supplier's IQC scheme.

5.2.6.1 Vicat softening temperature

Shall be conform NEN-EN-ISO 1452-2:2009 Article 9,
within addition:

- The test piece shall be cut from the wall of a pipe.

5.2.6.2 Longitudinal reversion

Shall be conform NEN-EN-ISO 1452-2:2009 Article 9,
within addition:

- Method: air oven or liquid bath with e.g. glycerine.



5.2.6.3 Resistance to dichloromethane

Shall be conform NEN-EN-ISO 1452-2:2009 Article 9.

Note: If the resistance to dichloromethane cannot be performed, the uniaxial tensile strength or the DSC test according to NEN-EN-ISO 1452-2:2009 Article 9 can be used.

5.2.7 **Marking of PVC-U drinking water pipes**

The pipes are provided with at least the following markings:

- **KIWA**  or  which is allowed for small diameters after consultation with Kiwa;
- supplier's name, trade name;
- material identification: PVC-U;
- nominal pressure: PN;
- nominal outside diameter and nominal wall thickness in mm;
- production code "year" and "week" ¹⁾;
- extruder number ¹⁾.

Location of the markings: on each pipe at a spacing of less than 2 m.
The markings shall be clear, legible and indelible affixed on the pipe.

- 1) May be displayed, if desired, in code.

5.3 **PVC-O Pipes (biaxial oriented PVC-U)**

5.3.1 **General**

Fittings for non-oriented PVC-U pipes are also suitable for biaxial oriented pipes, dependant of the pressure classes.

The lowest pressure class shall be used for the nominal pressure (PN).

The supplier shall implement work instructions in his quality system for the processing of PVC-O pipes.

Note 1: Because of the orientation the material has a fibrous layered structure. Processing on site of the biaxial oriented PVC-U pipes like gluing, sawing and boring can be done in the same way as with non-oriented PVC-pipes, however the processed cutting edge can have another appearance.

Note 2: Treatments on site whereby the pipe is heated may cause unwanted deformations.

5.3.2 **Material**

5.3.2.1 **General requirements including VCM content and K-value**

Shall be conform NEN-EN 17176-1:2019 Article 5.1.

5.3.2.2 **Use of non-virgin material**

Shall be conform NEN-EN 17176-1:2019 Article 5.3,

within addition:

- The supplier shall demonstrate that the characteristics of the products manufactured from reprocessed material fulfil the requirements of this evaluation guideline. The supplier shall keep records of the reprocessed material in such a way that the pipes concerned are recognisable for the certification body.

5.3.2.3 **Density**

Shall be conform NEN-EN 17176-2:2019 Article 5.2.

5.3.2.4 **MRS**

Shall be conform:

- NEN-EN 17176-1:2019 Article 6.1;
- NEN-EN 17176-2:2019 Article 5.3.

5.3.2.5 *Design stress*

Shall be conform NEN-EN 17176-1:2019 Article 6.3.

5.3.2.6 *Orientation factor*

Shall be conform NEN-EN 17176-2:2019 Article 5.4,

within addition:

- For the 'internal pressure test', end caps type A or B in accordance with NEN-EN-ISO 1167-1 may be used.
- The type of end cap used during the test has an effect on the test results.
- The applicant can chose which end cap will be used.
- The end caps used during the initial investigation will also be used during inspection tests.

5.3.3 *General characteristics*

5.3.3.1 *Appearance*

Shall be conform NEN-EN 17176:2019-2 article 6.1.

5.3.3.2 *Colour*

Shall be conform clause 4.6.2.

5.3.3.3 *Opacity*

Shall be conform NEN-EN 17176:2019-2 article 6.3.

5.3.3.4 *Classification of pipes*

Shall be conform NEN-EN 17176:2019-2 article 6.4.

5.3.4 *Geometrical characteristics*

Dimensions shall be measured conform NEN-EN 17176:2019-2 article 7.1.

5.3.4.1 *Length of pipes*

Shall be conform NEN-EN 17176:2019-2 article 7.2.

5.3.4.2 *Nominal outside diameters and wall thicknesses*

Including tolerances and out-of-roundness, shall be conform NEN-EN 17176:2019-2 article 7.3.

5.3.4.3 *Pipes with integral sockets with elastomeric sealing rings*

Shall be conform NEN-EN 17176:2019-2 article 7.4.

5.3.4.4 *Dimensions of pipe ends*

Shall be conform 5.2.3.7

5.3.5 *Selection of pipes*

Shall be conform NEN-EN 17176:2019-2 article 8

5.3.6 *Mechanical characteristics*

5.3.6.1 *Resistance to internal (hydrostatic) pressure*

Shall be conform NEN-EN 17176:2019-2 article 9.1, with the exception of the test period 1000 h at 20°C, which does not need to be performed.

Pipes with integral sockets shall be conform NEN-EN 17176:2019-2 article 9.1.3.

5.3.6.2 *Impact strength*

Shall be conform NEN-EN 17176:2019-2 article 9.2.

within addition:

- The test temperature is $(0 \pm 2) ^\circ \text{C}$.

5.3.7 *Physical characteristics*

The tests are carried out on non-oriented pipe.

5.3.7.1 *Vicat softening temperature*

Shall be conform NEN-EN 17176-2:2019 Article 10.



5.3.7.2 *Resistance to dichloromethane*

Shall be conform NEN-EN 17176-2:2019 Article 10, with an Immersion time of 30 minutes.

Note: If the resistance to dichloromethane cannot be performed, the uniaxial tensile strength or the DSC test according to NEN-EN 17176-2:2019 Article 10 can be used.

5.3.8 *Marking of PVC-O drinking water pipes*

The pipes are provided with at least the following markings:

- **KIWA**  or  which is allowed for small diameters after consultation with Kiwa;
- supplier's name, trade name;
- material identification: PVC-O 315 or PVC-O 355 or PVC-O 400 or PVC-O 450 PVC-O 500;
- biax only when orientation factor $\lambda_{\text{axial}} \geq 1,1$
- nominal pressure: PN;
- design coefficient $C = 1,4$ or $C = 1,6$
- nominal outside diameter and nominal wall thickness in mm or SDR;
- production code "year" and "week" ¹⁾;
- extruder number ¹⁾.

Location of the markings: on each pipe at a spacing of less than 2 m.

The markings shall be clear, legible and indelible affixed on the pipe.

1) May be displayed if desired in code.

6 Product requirements and test methods for PVC fittings

6.1 General

This chapter contains the requirements to which PVC fittings for the transport of drinking water have to comply with:

- fittings with elastomeric sealing rings, DN 50 up to and including DN 630;
- fittings for solvent cementing, DN 12 up to and including DN 160;
- bends made of PVC-U pipe, DN 50 up to and including DN 630;

6.2 Fittings with elastomeric sealing rings

6.2.1 Rubber

Elastomeric sealing ring shall meet the requirements of BRL-K17504.
See clause 4.4.

6.2.2 Material

6.2.2.1 General

See clause 4.3.1.

6.2.2.2 VCM content

See clause 4.3.2.

6.2.2.3 Density

See clause 4.3.3.

6.2.2.4 K value

See clause 4.3.4.

6.2.2.5 Classification and verification of the material

See clause 4.3.5.

6.2.3 General characteristics

6.2.3.1 Appearance

See clause 4.6.1.

6.2.3.2 Colour

See clause 4.6.2.

6.2.3.3 Opacity

See clause 4.6.3.

6.2.4 Geometrical characteristics

6.2.4.1 Determination of dimensions

Dimensions of the fittings shall be determined according to NEN-EN-ISO 3126.

6.2.4.2 Nominal diameter of fittings

The nominal inside diameter(s), d_n , of the fitting shall correspond to, and be designated by, the nominal outside diameter(s) of the pipe, d_n , for which the fitting is designed.

6.2.4.3 Dimensions of fittings with elastomeric sealing rings

The dimensions and tolerances of fittings with a elastomeric sealing ring shall comply with the requirements specified in NEN-EN-ISO 1452-3:2010, clause 6.7.

6.2.5 Mechanical characteristics

6.2.5.1 Resistance to impact of fitting

The impact strength of the fitting shall be determined according to NEN-EN 12061 taking into account the following additions / modifications:

- The impact strength of the fitting is tested by dropping it on a rigid surface. After the fall, the fitting is inspected with the naked eye without magnification. In case the fitting consists of separate components, these components shall be inspected also on damage that may have an effect on the leaktightness.
- Test temperature $(0 \pm 2)^\circ \text{C}$.
- Conditioning period $> 30 \text{ min}$ at 0°C .
- Drop height: 500 mm for $\text{DN} \leq 110$, 1000 mm for $\text{DN} > 125$.
- Point of impact: at random.

The fitting meets the requirements when the result can be expressed as "no damage" according to clause 7 of NEN-EN 12061:1999. The for impact resistance tested test pieces shall be used for testing the leaktightness.

6.2.5.2 Resistance to internal pressure of injection moulded fittings

The fittings shall withstand the prescribed internal pressure without cracking. Further no leakage is allowed during the test period. The test shall be carried out in accordance with NEN-EN-ISO 1167, all parts, taking into account the additions / modifications listed in Table 11. For this test, end caps type A or B in accordance with NEN-EN-ISO 1167-1 may be used. In case of dispute, end caps type A shall be used.

For the purpose of testing the fittings shall be assembled on PVC pipes of the same pressure class as the fitting, or fittings shall be sealed with end caps.

Note Type of end cap used during the test has an effect on the test results.

Table 11 – Test parameters for the determination of the resistance to internal pressure of injection moulded fittings of PVC

Nominal diameter / C	Test temperature (°C)	Test duration (hours)	Test pressure 1) (bars)
$dn < 160 / C = 2,5$	20	1	$4,2 \times PN$
$dn \geq 160 / C = 2,0$	20	1	$3,36 \times PN$
$dn < 160 / C = 2,5$	20	100	$3,5 \times PN$
$dn \geq 160 / C = 2,0$	20	100	$2,8 \times PN$
$dn < 160 / C = 2,5$	40	1000	$2,1 \times PN$
$dn \geq 160 / C = 2,0$	40	1000	$1,68 \times PN$

1) The test pressure, expressed in bar, shall be determined using the following equation:

$$p = C \times \frac{\sigma_{T,t}}{MRS} \times PN;$$

Where:
 PN is the nominal pressure expressed in bars;
 C is the design coefficient (C= 2,5 or C = 2,0);
 $\sigma_{T,t}$ corresponding value listed in table 2;
 MRS is minimum required strength (i.e. 25 MPa).
 Test: water-in-water.
 Number of test pieces: 3 for each test condition.

6.2.5.3 Resistance to internal pressure of couplers made of pipe or made by machining

The fittings shall withstand the prescribed internal pressure without cracking. Further no leakage is allowed during the test period. The test shall be carried out in accordance with NEN-EN-ISO 1167, all parts, taking into account the additions / modifications listed in Table 12. For this test, end caps type A or B in accordance with NEN-EN-ISO 1167-1 may be used. In case of dispute, end caps type A shall be used.

For the purpose of testing the fittings shall be assembled on PVC pipes of the same pressure class as the fitting, or fittings shall be sealed with end caps.

Note Type of end cap used during the test has an effect on the test results.

Determine the test pressure, p, using:

$$p = C \times \frac{\sigma_{T,t}}{MRS} \times PN$$

Table 12 – Test parameters for the determination of the resistance to internal pressure

Temperature (°C)	Test duration (hours)	Test pressure (bar)
20	1	$C \times \frac{42,00}{MRS} \times PN$
20	100	$C \times \frac{35,00}{MRS} \times PN$
60	1000	$C \times \frac{10,00}{MRS} \times PN$
$\sigma_{T,t}$ is corresponding value from table 2 C is the applicable design coefficient; C = 2,0 or C = 2,5, depending of the nominal size of the fitting. PN is pressure class of the fitting tested.		

6.2.6 Physical characteristics

6.2.6.1 Vicat softening temperature

The Vicat softening temperature shall be determined according to NEN-EN 727. Injection moulded fitting meet the requirement when the Vicat softening temperature is ≥ 74 °C.

For fittings made from pipe the Vicat softening temperature shall be ≥ 80 °C.

The test piece shall be cut from the wall of fitting.

6.2.6.2 Assessment of the effect of heating

Three complete mouldings shall be tested in accordance with NEN-EN-ISO 580 taking into account the following additions / modifications:

- Method A (forced-air oven).
- Heating temperature (150 ± 2) ° C.
- Heating time (see table 12a).

Table 12a – heating time for fittings with various mean wall thicknesses



Mean wall thickness (e_m) expressed in mm	heating period expressed in minutes
$e_m \leq 3$	15
$3 < e_m \leq 10$	30
$10 < e_m \leq 10$	60
$20 < e_m \leq 10$	140
$30 < e_m \leq 10$	220
$40 < e_m$	240

The surfaces of the moulding are examined before and after heating, and any cracks, blisters, delamination, or weld opening are measured and expressed as a percentage of the wall thickness.

The maximum dimensions of cracks, delamination, blisters, and flow joint openings, expressed as a percentage of the wall thickness should be less than 30 %.

6.2.7 **Marking of elastimeric ring seal fittings**

The fitting is provided with at least the following markings:

- **KIWA**  or on smaller products  or **KK** ¹⁾ or **KK** ¹⁾.
- supplier's name, trade name or logo;
- material identification PVC-U;
- nominal pressure PN;
- nominal size of the socket ends in mm;
- indication of the field of application;
- production period ²⁾

The markings shall be clear, legible and indelible affixed on the fitting.

- 1) For small fittings marking with **kk** only is allowed.
- 2) May be displayed if desired in code.

The smallest packaging unit of the fittings shall be marked with at least the following information:

- **KIWA** ;
- supplier's name, trade name, system name, logo or certificate number of the corresponding product (system) certificate, in accordance with the marking on the connecting pipe;
- nominal outside diameter and nominal wall thickness in mm of the connecting pipe;
- material identification, if the fitting body is made of plastic;

The markings shall be clear, legible and indelible affixed on each package.

6.3 Fittings for solvent cemented joint

6.3.1 Adhesive instruction

The supplier of the fittings shall deliver the products with an instruction for gluing.

6.3.2 Material

6.3.2.1 General

See clause 4.3.1.

6.3.2.2 VCM content

See clause 4.3.2.

6.3.2.3 Density

See clause 4.3.3.

6.3.2.4 K value

See clause 4.3.4.

6.3.2.5 Classification and verification of the material

See clause 4.3.5.

6.3.3 General characteristics

6.3.3.1 Appearance

See clause 4.6.1.

6.3.3.2 Colour

See clause 4.6.2.

6.3.3.3 Opacity

See clause 4.6.3.

6.3.4 Geometrical characteristics

6.3.4.1 Determination of dimensions

Dimensions of the fittings shall be determined according to NEN-EN-ISO 3126.

6.3.4.2 Nominal diameter of fittings

The nominal inside diameter(s), d_n , of the fitting shall correspond to, and be designated by, the nominal outside diameter(s) of the pipe, d_n , for which the fitting is designed.

6.3.4.3 Dimensions of fitting for solvent cementing

The dimensions and tolerances of fittings for solvent cementing shall comply with the relevant requirements specified in EN-EN-ISO 1452-3:2010, clause 6.3 and the following additions listed in the tables 13 and 14.

Table 13 – Minimum wall thickness ¹⁾ of injection moulded PVC-U solvent cement fittings (in mm)

Nominal diameter	Material designation PVC-U 200 fittings for nominal pressures of:			Material designation PVC-U 250 fittings for nominal pressures of:		
	PN 10	PN 12,5	PN 16	PN 10	PN 12,5	PN 16
12	2,0	2,0	2,0	2,0	2,0	2,0
16	2,0	2,0	2,0	2,0	2,0	2,0
20	2,0	2,0	2,0	2,0	2,0	2,0
25	2,0	2,0	2,4	2,0	2,0	2,0
32	2,0	2,4	3,0	2,0	2,0	2,4
40	2,4	3,0	3,8	2,0	2,4	3,0
50	3,0	3,8	4,7	2,4	3,0	3,7
63	3,8	4,8	5,9	3,0	3,8	4,7
75	4,5	5,7	6,9	3,6	4,5	5,6
90	5,4	6,8	8,3	4,3	5,4	6,7

1. In any cross-section the wall thickness of the fittings shall be no less than the values listed in this table.

Table 14 – Inside diameters of the sockets (in mm)

Nominal size of the fitting	Mean inside diameter of the socket		Out-of-roundness ¹⁾
	min.	max.	
12	12,0	12,3	0,2
16	16,0	16,3	0,2
20	20,0	20,3	0,2
25	25,0	25,3	0,2
32	32,0	32,3	0,3
40	40,0	40,3	0,3
50	50,0	50,3	0,4
63	63,0	63,3	0,5
75	75,0	75,3	0,6
90	90,0	90,3	0,7
110	110,1	110,4	0,8
125	125,1	125,4	0,9
160	160,2	160,5	1,0

- 1) Tolerance: $0,007 \times d_e$ in (d_e = the nominal outside diameter of the connecting pipe).

6.3.5 Mechanical characteristics

6.3.5.1 Resistance to impact of fitting

The impact strength of the fitting shall be determined according to EN 12061 taking into account the following additions / modifications:

- The impact strength of the fitting is tested by dropping it on a rigid surface. After the fall, the fitting is inspected with the naked eye without magnification. In case the fitting consists of separate components, these components shall be inspected also on damage that may have an effect on the leaktightness.
- Test temperature $(0 \pm 2) ^\circ \text{C}$.
- Conditioning period > 30 min at $0 ^\circ \text{C}$.
- Drop height: 500 mm for $d_n \leq 110$, 1000 mm for $d_n > 125$.
- Point of impact: at random.

The fitting meets the requirements when the result can be expressed as "no damage" according to clause 7 of EN 12061:1999. The for impact resistance tested test pieces shall be used for testing the leaktightness.

6.3.5.2 Resistance to internal pressure of injection moulded fittings for solvent cemented joints

The fittings shall withstand the prescribed internal pressure without cracking. Further no leakage is allowed during the test period. The test shall be carried out in accordance with NEN-EN-ISO 1167, all parts, taking into account the additions / modifications listed in Table 15. For this test, end caps type A or B in accordance with NEN-EN-ISO 1167-1 may be used. In case of dispute, end caps type A shall be used.

For the purpose of testing the fittings shall be assembled on PVC pipes of the same pressure class as the fitting, or fittings shall be sealed with end caps.

Note Type of end cap used during the test has an effect on the test results

Table 15 – Test parameters for the determination of the resistance to internal pressure

Test temperature (°C)	Test duration (hours)	Test pressure ¹⁾ (bars)
20	1	$C \times \frac{42,00}{MRS} \times PN$
	100	$C \times \frac{35,00}{MRS} \times PN$
	1000	$C \times \frac{31,87}{MRS} \times PN$
<p>1) The test pressure, expressed in bar, shall be determined using the following equation:</p> $p = C \times \frac{\sigma_{T,t}}{MRS} \times PN;$ <p>Where: PN is the nominal pressure expressed in bars; C is the design coefficient (C= 2,5 or C = 2,0); $\sigma_{T,t}$ corresponding value listed in table 2; PVC-U MRS is minimum required strength (i.e. 25 MPa). Test: water-in-water. Number of test pieces: 3 for each test condition.</p>		

6.3.6 Physical characteristics

6.3.6.1 Vicat softening temperature

The Vicat softening temperature shall be determined according to NEN-EN 727. Injection moulded fitting meet the requirement when the Vicat softening temperature is ≥ 74 °C.

For fittings made from pipe the Vicat softening temperature shall be ≥ 80 °C.

The test piece shall be cut from the wall of a fitting.

6.3.6.2 Assessment of the effect of heating

Three complete mouldings shall be tested in accordance with NEN-EN-ISO 580 taking into account the following additions / modifications:



- Method A (forced-air oven).
- Heating temperature (150 ± 2) ° C.
- Heating time (see table 12a).

The surfaces of the moulding are examined before and after heating, and any cracks, blisters, delamination, or weld opening are measured and expressed as a percentage of the wall thickness.

The maximum dimensions of cracks, delamination, blisters, and flow joint openings, expressed as a percentage of the wall thickness should be less than 30 %.

6.3.7 **Marking of PVC-U and PVC-UH fittings voor solvent cementing joints**

The fitting is provided with at least the following markings:

- **KIWA**  or on smaller products  or $\overline{\text{KK}}$ ¹⁾ or KK¹⁾.
- supplier's name, trade name or logo;
- material identification PVC-U;
- nominal pressure PN;
- nominal size of the socket ends in mm;
- indication of the field of application;
- production period²⁾

The markings shall be clear, legible and indelible affixed on the fitting.

- 1) For small fittings marking with kk only is allowed.
- 2) May be displayed if desired in code.

The smallest packaging unit of the fittings shall be marked with at least the following information:

- **KIWA** ;
- supplier's name, trade name, system name, logo or certificate number of the corresponding product (system) certificate, in accordance with the marking on the connecting pipe;
- nominal outside diameter and nominal wall thickness in mm of the connecting pipe;
- material identification, if the fitting body is made of plastic;

The markings shall be clear, legible and indelible affixed on each package.

6.4 **Bends made from pipe**

In this BRL the requirements are laid down for bends which are made from PVC-U pipe and are bend after a heating. Bends are produced with the following nominal angles: 11°, 22°, 30°, 45°, 60° and 90°.

6.4.1 **General**

Under normal operational conditions, the life span of the bends shall be at least equal to the life span of the connecting pipes. The production process shall be such that the mechanical characteristics of the PVC material are not adversely affected.

The bends shall be made from PVC-U pipes that comply with the clauses 5.2.1 and 5.2.2.

6.4.2 **Geometrical characteristics**

6.4.2.1 *Determination of dimensions*

Dimensions of the fittings shall be determined according to NEN-EN-ISO 3126.

6.4.2.2 *Nominal diameter of bend*

The nominal inside diameter(s), d_n , of the bend shall correspond to, and be designated by, the nominal outside diameter(s) of the pipe, d_n , for which the fitting is designed.

The nominal outside diameters may have only those values as specified in clause 5.2.3.2.

6.4.2.3 Permitted dimensional variation of the outside diameters and wall thicknesses at the ends

For the outside diameters and the minimum wall thickness at the ends of the bend, the values with the associated tolerances in accordance with clause 5.2.3.3 apply.

6.4.2.4 Permitted dimensional variation of the outside diameters and wall thicknesses at the location of the portion of the curve

For the outside diameters and the minimum wall thickness at the location of the portion of the curve the values listed in table 16 apply.

Table 16 – Permissible tolerances at the location of the portion of the curve

Size	Permitted dimensional variation
Mean outside diameter (d_{em})	$\pm 0,025 \times d_n$
Out-of-roundness ($d_{e,max} - d_{e,min}$)	$\leq 0,05 \times d_n$
Wall thickness of the bend ($e_{min,bocht}$)	$\geq 0,93 \times e_{min,buis}$
d_n	= nominal diameter
d_{em}	= mean outside diameter
e	= wall thickness
$e_{min,bocht}$	= minimum permissible wall thickness of the bend
$e_{min,buis}$	= minimum permissible wall thickness of the connecting pipe
$d_{e min}$	= smallest outside diameter at any point
$d_{e max}$	= greatest outside diameter at any point

6.4.2.5 Angles

The nominal angles are 11°, 22°, 30°, 45°, 60° and 90°. The permissible deviation on the nominal angle is $\pm 2^\circ$.

6.4.2.6 Radius of curvature of bends

The radius of curvature of the centre line of the bend should be not less than 3.5 x the diameter.

6.4.2.7 Installation dimensions (Z lengths)

The Z-dimensions shall be in accordance with the values specified by the supplier. This requires that the supplier provides drawings to the certification body.

6.4.3 Bend ends

The chamfer at the ends of bends shall comply to clause 5.2.3.8.

6.4.4 Bends with sockets for solvent cementing

The dimensions of integral sockets for solvent cementing shall meet the requirements specified in clause 5.2.3.6.

6.4.5 Mechanical characteristics

In order to verify whether the heating and cooling during the production of the bend caused any impermissible decline of the mechanical characteristics, the following type tests shall be carried out.

Subject straight pipe pieces to the heating treatment and cooling down process as it is usual for the manufacturing of the bends concerned. The instructions of the heat treatment and the cooling process should be made available by the supplier to the certification body. Then carry out the following tests.

6.4.5.1 Resistance to impact

See clause 5.2.5.1.

6.4.5.2 Resistance to internal pressure

The pipes shall withstand the prescribed internal pressure without cracking. Further no leakage is allowed during the test period. The test shall be carried out in accordance with NEN-EN-ISO 1167, all parts, taking into account the additions / modifications listed in Table 17. For this test, end caps type A or B in accordance with NEN-EN-ISO 1167-1 may be used. In case of dispute, end caps type A shall be used.

For the purpose of testing the fittings shall be assembled on PVC pipes of the same pressure class as the fitting, or fittings shall be sealed with end caps.



Note Type of end cap used during the test has an effect on the test results.

Table 17 – Test parameters for the determination of the resistance to internal pressure

Temperature (°C)	Duration of the test (hours)	Circumferential stress in the pipe wall (MPa)
20	100	35,0
60	1000	12,5 ¹⁾
Test: water-in-water		
If tested with the circumferential stress of 12,5 MPa, due to statistical spread of the test results, test times less than 1 000 h can be achieved. In this case, a retest procedure with a circumferential stress of 12,5 MPa or 10,0 MPa shall be performed with pipes of the same production batch and double sampling. If the retest results are positive, the requirement of the minimum reference curve for PVC-U 250, given in ISO 1452-1:2009, 4.4.2, is deemed to be verified.		

6.4.6 Markings bends made from PVC-U drinking water pipes

The bends are provided with at least the following markings:

- **KIWA**  or  which is allowed for small diameters after consultation with Kiwa;
- supplier's name, trade name;
- material identification: PVC-U;
- PN class;
- nominal outside diameter in mm;
- production code ¹⁾;
- extruder number ¹⁾.

The markings shall be clear, legible and indelible affixed on the bend.

- 1) May be displayed if desired in code.

7 Product requirements and test methods for special fittings

7.1 General

In this chapter the requirements are embodied to which:

- saddles of PVC-U (DN 40 up till and including 630 mm);
- end-load-bearing double-sockets of PVC;
- injection moulded PVC fittings with flange connections;
- double sockets and end-load-bearing double-sockets of PVC-U with a ventilation construction;

for the transport of drinking water have to comply with.

7.2 Saddles of PVC-U

7.2.1 General

These requirements apply to saddles of PVC-U with internal, conical screw threads: Gk 1/2", Gk 3/4" or Gk 1", intended for usage in combination with metal service taps. The saddles are intended for assembly with PVC-U drinking water pipes according to paragraph 5.2.

7.2.2 Material

See clause 4.3

7.2.3 Elastomeric rings

The elastomeric rings shall comply the requirements specified in BRL-K17504 (see also clause 4.4).

7.2.4 General characteristics

7.2.4.1 Appearance

See clause 4.6.1.

7.2.4.2 Colour

See clause 4.6.2.

7.2.4.3 Opacity

See clause 4.6.3.

7.2.5 Construction and design

The construction of the saddle parts must be such that the parts only can be assembled together in one position.

The direction of how the clamps must be tarnished, must be indicated on each clamp by means of an arrow.

On the inside and outside surface of the saddles no sharp transitions may occur in order to avoid notch effect.

The slope of the spigot ways on the saddles and in the clamps may not be more than 7°. The spigot ways must be rounded to a radius of at least 1,5 mm. The aberration of the straightness of the spigot ways may not be more than $0,08 \times l_s$ (l_s = length of spigot way).

The seal between saddle and pipe must be a profiled rubber ring. The rubber sealing ring must be centred in the saddle chamber in such a way that the ring cannot be moved or come out the chamber when assembled.

7.2.6 Geometrical characteristics

7.2.6.1 Determination of dimensions

Dimensions of the fittings shall be determined according to NEN-EN-ISO 3126.

7.2.6.2 Inside diameters of the saddles

The inside diameters of the saddles must be adapted to the outside diameter of the PVC pipes for which they are intended. Hereby the for the pipes applicable tolerances for the outside diameters of the pipes must be taken into account.

7.2.6.3 Wall thickness of the saddles

In any cross-section the wall thickness shall not be smaller than the values as indicated in table 18.

Table 18 – Wall thickness of the saddles (in mm)

Corresponding pipe size	Wall thickness of saddle, minimum (mm)	Corresponding pipe size	Wall thickness of saddle, minimum (mm)
40	5,0	160	7,0
50	5,0	200	8,0
63	5,0	250	9,5
75	5,0	315	11,0
90	5,5	400	13,0
110	6,0	500	15,5
125	6,0	630	19,0

The wall thickness at the connection end, measured outside the screw thread, must be at least 8 mm.

7.2.6.4 Length of the saddles

The length of the saddles (measured in the direction of the pipe) depends on the outside diameter of the corresponding PVC pipes and shall be smaller than the values as indicated in table 19.

Table 19 – Minimum permissible length of the saddles (in mm)

Saddles intended for pipes with outside diameters of:	Minimum permissible length of the saddle
40, 50	60
63, 75, 90	65
110, 125	75
160, 200	80
225	95
≥ 250	100

7.2.7 Screw-thread in the saddles

The following requirements apply for the screw threads:

- The design of the screw thread shall meet the requirements for taper internal threads according to NEN-EN 10226-2;
- the dimensions of the screw thread shall meet the requirements specified in table 21;
- the screw thread shall be smooth and sound, free of burrs or other irregularities.

The minimum and maximum tolerances of the dimensions of the screw thread in the saddle is assessed with the aid of two gauges (maximum and minimum) or a jig which is provided with a flat plane with which the minimum and maximum sizes are indicated. The determination shall be carried out with gauges that comply to the applicable ANSI / ASME standards.

The dimensions of the screw threads shall meet the requirements specified in table 20.

Table 20 – Dimensions of the screw threads in the saddles (in mm)

Screw thread	When fitted with a max. gauge the screw length (L) shall be at least:		Effective length of the screw thread (S) shall be at least:
	When fitted with a max. gauge the screw length (L) shall be at least:	When fitted with a min. gauge the screw length (L) shall be at least:	
Gk 1/2"	9,7 (5,5 threads)	15,4 (8,5 threads)	19
Gk 3/4"	10,7 (6 threads)	16,4 (9 threads)	20
Gk 1"	10,0 (4,5 threads)	17,4 (7,5 threads)	22

The dimensions of the gauges shall comply to the requirements listed in table 21.

Table 21 – Dimensions of the gauges

Screw thread size	Max. gauge		Min. gauge	
	L ₁	L ₂	L ₁	L ₃
Gk 1/2"	16,3	6	16,3	9
Gk 3/4"	17,3	10	17,3	13
Gk 1"	18,5	10	18,5	14

7.2.8 Mechanical characteristics

7.2.8.1 Resistance to impact

The determination of the resistance to impact is based ISO 3127.

The main frame of the test set-up tower and the striker shall comply with the respective requirements of ISO 3127. Figure 5 is a drawing is given of a bearing and the seat test piece. The sides of the test specimen should be supported as shown in Figure 3 by means of adjustable side supports.

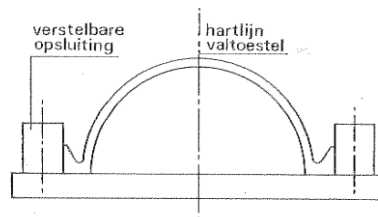

Figure 3 - Support of the saddle for the impact test

For testing the saddles shall be conditioned during at least 30 minutes at a temperature of $(0 \pm 2) ^\circ \text{C}$, e.g. using an ice / water mixture. The mass of the striker and the drop height dependent on the nominal diameter and are shown in Table 6.

Initially, there should be ten full saddles to be tested. (Upper and lower saddle) If an upper saddle or under saddle fails, the test shall be extended by a further 20 complete saddles (upper and lower saddle). Not more than 3 parts of the saddle 30 shall fail to satisfy the requirement ($<10\%$).

7.2.8.2 Resistance to internal pressure

A test piece comprising a length of PVC-U pipe and a saddle of the same PN must be able to withstand the required internal pressure without cracking. Further no leakage is allowed during the test period. Five test pieces shall be tested.

The installation of the saddle shall be carried out according to the instructions of the supplier. The PVC pipe used in the experiment shall comply with 5.2.

The test shall be performed according to clause 4.8.3.1.

7.2.8.3 Strength of the screw thread

For the determination of the strength of a the screw thread of the saddle for the connection with the service crane a special tool is required with the dimensions as shown in Table 22.

Table 22 – Dimensions of the special tool for the determination of the strength of the screw thread in the saddle (in mm).

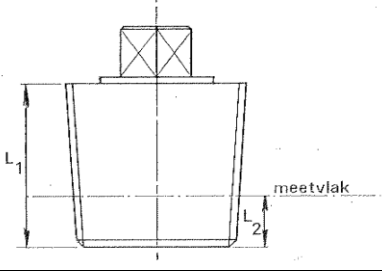

Screw thread size	L ₁ min	L ₂
Gk 1/2"	28	6
Gk 3/4"	29	10
Gk 1"	33	10

For testing, the test assembly is conditioned at a temperature of $(0 \pm 2) ^\circ \text{C}$ for at least 30 minutes. Then, the special tool is turned into the screw thread of the saddle knob until the friction is equal to a moment of 1 N / m. From this position the tool is turned for four extra revolutions. The saddle with the screwed-in tool is maintained for 100 hours at a temperature of (0 ± 2) .

The saddle meet to the requirement as no breakage or cracking occurs during this period.

7.2.8.4 Resistance to compression

For the determination of the resistance to compression of the saddle, equipment according to NEN-ISO 5893 is needed in which a seat with a speed of 35 mm / min can be compressed diametrically in a test set-up shown in Figure 6.

Place the saddle between two parallel plates positioned relative to each other which are provided with suitable support for the test piece as shown in Figure 4. The compression is performed up to the distance a up to 50% of its original value has been reduced.

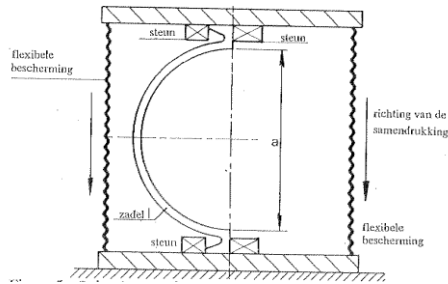

Figure 4 - Supports of the saddle during the compression test

Five test piece shall be tested. The saddle meet the requirement when no fracture or cracking occurred.

7.2.9 Physical characteristics

7.2.9.1 Vicat softening temperature

The Vicat softening temperature shall be determined according to NEN-EN 727. Injection moulded fitting meet the requirement when the Vicat softening temperature is ≥ 74 °C.

For fittings made from pipe the Vicat softening temperature shall be ≥ 80 °C. The test piece shall be cut from the wall of a fitting.

7.2.9.2 Assessment of the effect of heating

Three complete mouldings shall be tested in accordance with NEN-EN-ISO 580 taking into account the following additions / modifications:



- Method A (forced-air oven).
- Heating temperature (150 ± 2) ° C.
- Heating time (see table 12a).

The surfaces of the moulding are examined before and after heating, and any cracks, blisters, delamination, or weld opening are measured and expressed as a percentage of the wall thickness.

The maximum dimensions of cracks, delamination, blisters, and flow joint openings, expressed as a percentage of the wall thickness should be less than 30 %.

7.2.10 Markings of saddles for PVC-U drinking water pipes

The saddles are provided with at least the following markings:

- **KIWA**  or on smaller products  or **KK**¹⁾ or **KK**¹⁾.
- supplier's name, trade name;
- material identification: PVC-U;
- PN class;
- nominal outside diameter of the connecting pipe in mm;
- production code²⁾;

The markings shall be clear, legible and indelible affixed on each saddle.

- 1 For small fittings marking with kk only is allowed.
- 2 May be displayed if desired in code.

7.3 End-load-bearing double-sockets of PE and PVC

These section applies on end-load-bearing double-sockets with an angular deflection of not more than 3 °.

7.3.1 General

The end-load-bearing double sockets shall have a strength and life that is at least equal to that of the PVC pipe of the same nominal pressure ratings.

The end-load-bearing double sockets shall be manufactured according to a controlled production process.

The end-load-bearing double sockets shall have a shape that the full flow profile of the tube is maintained.

The end-load-bearing double sockets may contain no welded PVC-U parts.

During mounting the fitting to the pipe, it is not allowed to apply notches, groves or other modifications that can have a negative effect on the life span of the piping system.

The end-load-bearing double sockets shall be installed according to the supplier's instructions.

7.3.2 Material

7.3.2.1 Pipe material of PVC-U

Double sockets and sleeves which are made from PVC-U pipes shall, apart from size, comply to clause 5.2.

7.3.2.2 Polyethylene material

The polyethylene material of end-load-bearing fittings of polyethylene (PE) shall meet the requirements listed in EN 12201-1:2011, tables 1 and 2.

7.3.3 Elastomeric sealing rings

The rubber sealing rings of the end-load-bearing fittings shall comply with BRL-K17504. (see section 4.4).

7.3.4 Adhesives and cleaning products

Adhesives and cleaning products may have no harmful effect on the PVC material. PVC adhesives shall comply with BRL-K525.

7.3.5 Locking device and its components

The locking device shall comply to the specifications of the supplier with regard to material, dimensions and permissible deviations. The supplier must provide this specification to the certification body.

7.3.6 General characteristics

7.3.6.1 Appearance

See clause 4.6.1.

7.3.6.2 Colour

End-lead-bearing fittings of PE shall be preferably black or blue

End-lead-bearing fittings of PVC-U shall be dark grey, blue or cream. For aboveground application the colour cream is not allowed.

7.3.6.3 Opacity

See clause 4.6.3.

7.3.7 Geometrical characteristics

7.3.7.1 Determination of dimensions

Dimensions of the fittings shall be determined according to NEN-EN-ISO 3126.

7.3.7.2 Nominal diameter of the end-load-bearing couplers with elastomeric sealing rings

The nominal inside diameter(s), d_n , of the fitting shall correspond to, and be designated by, the nominal outside diameter(s) of the pipe, d_n , for which the fitting is designed.

7.3.7.3 Dimensions of end-load-bearing fittings with elastomeric sealing elements

For those parts of the end-load-bearing fitting that are exposed to internal pressure applies that the minimum wall thickness of the sockets and spigots, except the sealing ring groove, shall be not less than the minimum wall thickness of the connecting pipe as specified in NEN-EN-ISO 1452-2.

Polyethylene end-load-bearing fittings shall comply to NEN-EN 12201-3. The nominal pressure of the fitting shall be at least the nominal pressure of the piping system.

The depth of engagement behind the elastomeric sealing element shall be at least two times tolerance and the distance of the chamfered portion (see figure 5).

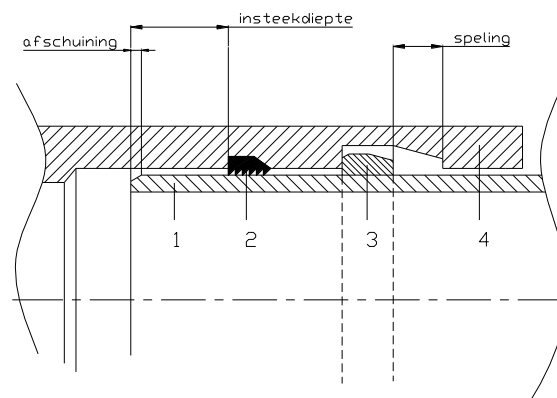

1. pipe
2. elastomeric sealing element
3. clamp element
4. part of end-load-bearing fitting.

Figure 5 – Depth of engagement of the end-load-bearing fitting.

The dimensions and permissible tolerances of the end-load-bearing fitting and all other parts shall be provided by the supplier to the certification body.

7.3.7.4 Dimensions of solvent cemented joint between PVC sleeve and pipe

The design of the connection shall comply to NEN-EN-ISO 1452-3:2010, figure 25.

The length for solvent cementing of the sleeve may not be smaller than $0,5 \times$ the nominal diameter of the pipe, d_n .

Sleeves shall have an inside diameter (d_s) of:

$$d_s = d_n^{+0,003 \times d_e}_{-0,2};$$

with a maximum permissible tolerance of $d_s - d_n = 0,8$ mm.

7.3.8 Mechanical characteristics

7.3.8.1 Resistance to impact

The cylindrical part of the end-load-bearing fitting shall comply with clause 5.2.5.1.

7.3.9 Physical characteristics

7.3.9.1 Vicat softening temperature

The Vicat softening temperature shall be determined according to NEN-EN 727 and for PVC-U fitting only.

Injection moulded end-load-bearing fittings meet the requirement when the Vicat softening temperature is ≥ 74 °C.

The test piece shall be cut from the wall of a fitting.

7.3.9.2 Oxidation induction time

The oxidation induction time (OIT) shall be determined according to NEN-EN-ISO 11357-6, at a test temperature of 200 °C and for polyethylene material only.

The sample meet the requirements as the oxidative induction time is greater than 20 minutes.

7.3.9.3 Assessment of the effect of heating

Three complete mouldings shall be tested in accordance with NEN-EN-ISO 580 taking into account the following additions / modifications:

- Method A (forced-air oven).
- Heating temperature (150 ± 2) ° C.
- Heating time (see table 12a).

The surfaces of the end-load-bearing fitting are examined before and after heating, and any cracks, blisters, delamination, or weld opening are measured and expressed as a percentage of the wall thickness.

The maximum dimensions of cracks, delamination, blisters, and flow joint openings, expressed as a percentage of the wall thickness should be less than 30 %.

7.3.10 Joint requirements end-load-bearing double socket couplers

7.3.10.1 Leaktightness and strength while subjected to bending and internal pressure

The leaktightness and strength of the joint shall be determined according to NEN-EN-ISO 13783. The number of test pieces is 3.

The joint fulfils the requirements when no leakage, deformations nor cracking in the assembly are detected during the test.

7.3.10.2 Long-term leaktightness under internal pressure



The long-term leaktightness under internal pressure shall be determined according to NEN-EN-SIO 13846 taking into account the following additions / modifications:

- Number of test pieces is 3.
- The test is carried out at a temperature of 40^{+3}_{-1} °C.
- Test duration is 1000 hours.
- Test pressure is 1,3 x PN.

The joint fulfils the requirements when no leakage nor cracking in the assembly are detected during the test.

7.3.11 Marking end-load-bearing fittings of PE and PVC-U for drinking water pipes

The end-load-bearing fittings are provided with at least the following markings:

- **KIWA**  or on smaller products  or **KK**¹⁾ or **KK**¹⁾.
- supplier's name, trade name;
- material identification, e.g: PVC-U, PE80 or PE100;
- PN class;
- nominal outside diameter of the connecting pipe in mm;
- production code²⁾;

The markings shall be clear, legible and indelible affixed on each saddle.

- 1 For small fittings marking with kk only is allowed.
- 2 May be displayed if desired in code.

7.4 Injection moulded PVC fittings with flange connections

In this clause the requirements and test methods are listed for injection moulded fittings of PVC-U that are provided with flange connections and socket ends with rubber sealing elements (see figure 6).

The flange of the fitting is intended for the making of a connection with a metal fitting or an accessory with a flange in PVC drinking water piping systems.

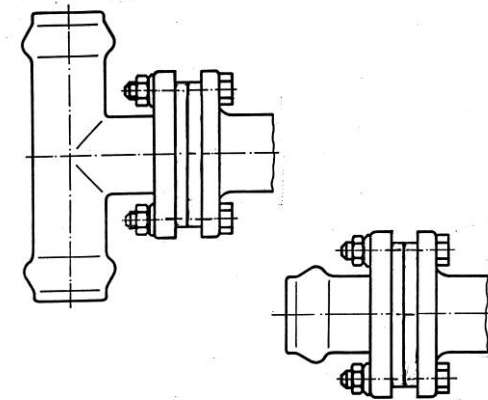

Figure 6 – Implementation of joints

7.4.1 General

The pipes to be connected with the fittings must comply with paragraph 5.2. The joint shall be assembled according to the supplier's instructions.

7.4.2 Material

See clause 4.3.

7.4.3 Rubber

See clause 4.4.

7.4.4 General characteristics

7.4.4.1 Appearance

See clause 4.6.1.

7.4.4.2 Colour

The fittings shall be dark grey and shall comply with clause 4.6.2.

7.4.4.3 Opacity
See clause 4.6.3.

7.4.5 Geometrical characteristics

7.4.5.1 Determination of dimensions
Dimensions of the fittings shall be determined according to NEN-EN-ISO 3126.

7.4.5.2 Nominal diameter of the fittings
The nominal inside diameter(s), d_n , of the fitting shall correspond to, and be designated by, the nominal outside diameter(s) of the pipe, d_n , for which the fitting is designed.

7.4.5.3 Dimensions of the fittings
The dimensions of the flanges and flange connections shall meet the requirements as specified in NEN-EN-ISO 1452-3:2010, tables 11, 12, 19, 20, the one that is applicable.

7.4.5.4 Dimensions of the flange connection
The sizes of the flange borings shall comply with the applicable normalized values. The other values of the dimensions of the fittings shall be provided by the supplier in drawings to the certification body.

7.4.6 Mechanical characteristics

7.4.6.1 Impact resistance of fitting
The impact strength of the fitting shall be determined according to EN 12061 taking into account the following additions / modifications:

- The impact strength of the fitting is tested by dropping it on a rigid surface. After the fall, the fitting is inspected with the naked eye without magnification. In case the fitting consists of separate components, these components shall be inspected also on damage that may have an effect on the leaktightness.
- Test temperature $(0 \pm 2) ^\circ \text{C}$.
- Conditioning period > 30 min at $0 ^\circ \text{C}$.
- Drop height: 500 mm for $\text{DN} \leq 110$, 1000 mm for $\text{DN} > 125$.
- Point of impact: at random.

The fitting meets the requirements when the result can be expressed as "no damage" according to clause 7 of EN 12061:1999. The for impact resistance tested test pieces shall be used for testing the leaktightness.

7.4.6.2 Resistance to internal pressure
The assembly shall withstand the prescribed internal pressure without cracking. Further no leakage is allowed during the test period. The test shall be carried out in accordance with NEN-EN-ISO 1167, all parts, taking into account the additions / modifications:

- number of test pieces is 3;
- test temperature is $40 ^\circ \text{C}$;
- test duration is 1000 hours;
- test type is "water-in-water";

For the purpose of testing the fittings shall be assembled on PVC pipes of the same pressure class as the fitting, or fittings shall be sealed with end caps. The rubber sealing elements may be secured in order to prevent that the rubber sealing element is pushed out of its groove.

7.4.7 Joint requirements

7.4.7.1 Strength and leaktightness of the flange connection

For the determination of the strength of the flange connection the fittings must be subjected, freely supported, to the bending tests I and II, or III as indicated in figure 11. During the test, the fittings must be subjected to an internal water pressure and a bending force K as listed in table 23. The duration of the test is 1000 hours and the test temperature is (23 ± 2) °C. During the test the test piece shall not fail, which means no fractures , no leakage.

Table 23 – Test parameters for the determination of the strengt hand leaktightness of the flange connection

Nominal size in mm	Internal pressure	bending force K in N
63	3,5 x PN	400
75	3,5 x PN	600
90	3,5 x PN	650
110	3,5 x PN	800
160	3,5 x PN	1500

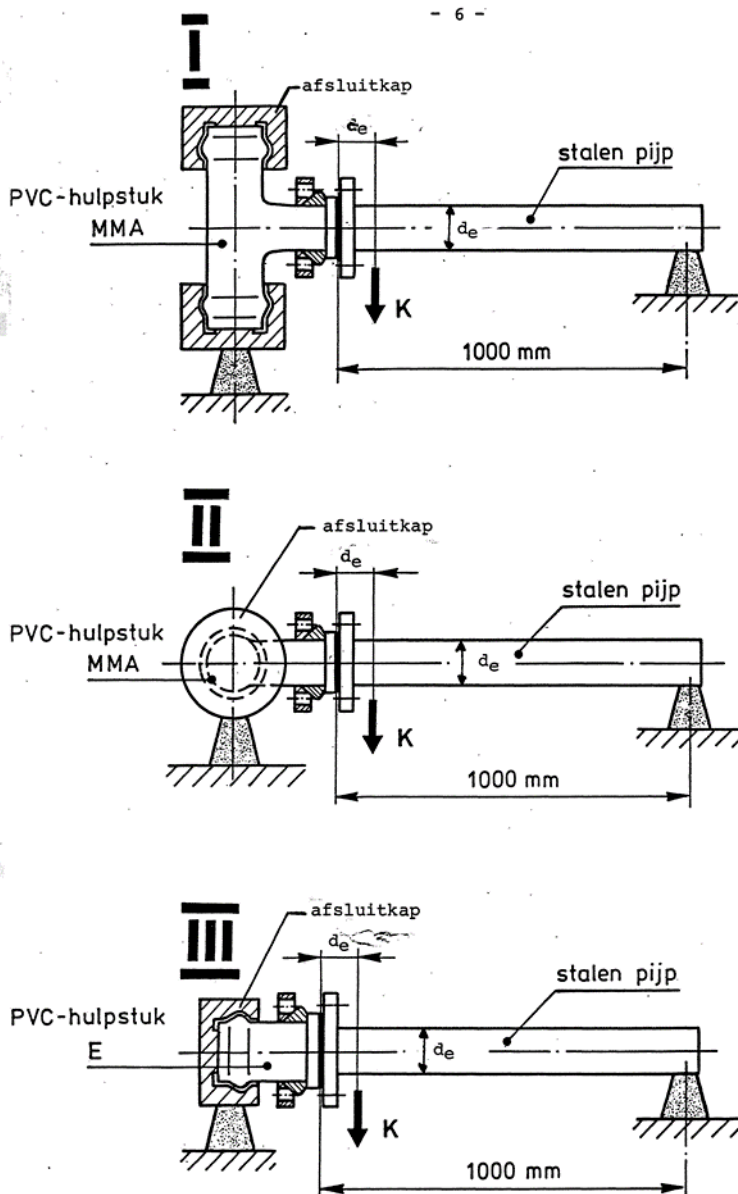



Figure 7 - Test set-up for the performance of the bending tests

7.4.8 Markings of injection moulded PVC-U fittings with flange connections voor drinking water pipes

The fittings are provided with at least the following markings:

- **KIWA**  or on smaller products  or \boxed{KK} ¹⁾ or KK ¹⁾.
- supplier's name, trade name;
- material identification: PVC-U;
- PN class;
- nominal outside diameter of the connecting pipe in mm;
- production code ¹⁾;

The markings shall be clear, legible and indelible affixed on each saddle.

- 1 For small fittings marking with kk only is allowed.
- 2 May be displayed if desired in code.

8 Requirements in respect of the quality system

This chapter contains the requirements which have to be met by the supplier's quality system.

8.1 Manager of the quality system

Within the supplier's organizational structure, an employee who will be in charge of managing the supplier's quality system must have been appointed.

8.2 Internal quality control/quality plan

The supplier shall have an internal quality control scheme (IQC scheme) which is applied by him.

The following must be demonstrably recorded in this IQC scheme:

- which aspects are checked by the supplier;
- according to what methods such inspections are carried out;
- how often these inspections are carried out;
- in what way the inspection results are recorded and kept.

This IQC scheme should at least be an equivalent derivative of the model IQC scheme as shown in the Annex II.

8.3 Control of test and measuring equipment

The supplier shall verify the availability of necessary test and measuring equipment for demonstrating product conformity with the requirements in this evaluation guideline.

When required the equipment shall be kept calibrated (e.g recalibration at interval).

The status of actual calibration of each equipment shall be demonstrated by traceability through a unique ID.

The supplier must keep records of the calibration results.

The supplier shall review the validity of measuring data when it is established at calibration that the equipment is not suitable anymore.

8.4 Procedures and working instructions

The supplier shall be able to submit the following:

- procedures for:
 - dealing with products showing deviations;
 - corrective actions to be taken if non-conformities are found;
 - dealing with complaints about products and/or services delivered;
- the working instructions and inspection forms used.

9 Summary of tests and inspections

This chapter contains a summary of the following tests and inspections to be carried out in the event of certification:

- **initial investigation:** tests in order to ascertain that all the requirements recorded in the evaluation guideline are met;
- **inspection test:** tests carried out after the certificate has been granted in order to ascertain whether the certified products continue to meet the requirements recorded in the evaluation guideline;
- **inspection of the quality system of the supplier:** monitoring compliance of the IQC scheme and procedures.

Notes by the test matrix 9.1 - 9.8:

1. In case the product or production process changes significantly, the performance requirements shall be determined again.
2. During the inspection visit, the inspector shall check the product on the basis of a selection of the above listed requirements. The frequency of the inspection visits is recorded in clause 10.6 "Nature and frequency of external inspections".
3. If, for any reason verified by the CD, it is not possible to perform a test at a KIWA laboratory it is possible to perform the test under witness at a laboratory which is ISO 17025 certified.

9.1 Test matrix for PVC-U pipes

Description of requirement	Article no. of BRL	Controls within the scope of:			
		Initial investigation ³⁾	Inspection by Kiwa after granting of certificate ^{1,2,3)}	IQC Performed by the producer	
				At start-up	Frequency
General	5.1				
Toxicological requirements	4.2	x	1 per year		
Rubber sealing	4.4	x	1 per year		
Adhesive sealing	4.5	x	1 per year		
PVC-U Pipes	5.2				
Material	5.2.1				
General requirements	5.2.1.1	x			1 per batch
VCM content	5.2.1.1	x			1 per batch
K-value	5.2.1.2	x	1 per year		
Use of non-virgin material	5.2.1.3	x	1 per year		
Density	5.2.1.4	x	1 per year		
Classification and verification	5.2.1.5	x			Every 3 years
MRS value	5.2.1.5	x			Every 3 years
General characteristics	5.2.2				
Appearance	5.2.2.1	x	1 per year	x	1 per 8 h
Colour	5.2.2.2	x	1 per year	x	1 per 8 h
Opacity	5.2.2.3	x			
Geometrical characteristics	5.2.3				
Nominal outside diameter and tolerances	5.2.3.1	x		x	1 per 8 h
Mean outside diameter and tolerances	5.2.3.2	x		x	1 per 8 h
Wall thickness and their tolerances	5.2.3.3	x		x	1 per 8 h
Length of pipe	5.2.3.4	x		x	1 per 8 h
Dimensions of pipes with integral sockets for solvent cementing joints	5.2.3.5	x		x	1 per 8 h
Dimensions of pipes with integral sockets with rubber sealing rings type joints	5.2.3.6	x		x	1 per 8 h
Dimensions of pipe ends	5.2.3.7	x		x	1 per 8 h
Classification and selection of the pipes	5.2.4				
Classification and selection of the pipes	5.2.4	x			
Mechanical characteristics	5.2.5				
Impact strength	5.2.5.1	x	1 per year	x	1 per 7 days
Resistance to internal pressure: - 1 h at 20°C - 100 h at 20°C - 1000 h at 60°C	5.2.5.2	x	1 per year	x	1 per 7 days
Physical characteristics	5.2.6				
Vicat softening temperature	5.2.6.1	x	1 per year		
Longitudinal reversion	5.2.6.2	x	1 per year	x	1 per 7 days
Resistance to dichloromethane	5.2.6.3	x	1 per year	x	1 per 24 h
Marking of PVC-U drinking water pipes	5.2.7				
Marking of PVC-U drinking water pipes	5.2.7	x	1 per year	x	1 per 8 h

9.2 Test matrix for PVC-O pipes

Description of requirement	Article no. of BRL	Controls within the scope of:			
		Initial investigation ³⁾	Inspection by Kiwa after granting of certificate ^{1,2,3)}	IQC Performed by the producer	
				At start-up	Frequency
General	5.1				
Toxicological requirements	4.2	x	1 per year		
Rubber sealing	4.4	x	1 per year		
Adhesive sealing	4.5	x	1 per year		
PVC-O Pipes	5.3				
Work instructions	5.3.1	x	1 per year		
Material	5.3.2				
VCM content	5.3.2.1	x			1 per batch
K value	5.3.2.1	x	1 per year		
Use of non-virgin material	5.3.2.2	x	1 per year		
Density	5.3.2.3	x	1 per year		
MRS value	5.3.2.4	x			Every 3 years
Design stress	5.3.2.5	x			
Orientation factors	5.3.2.6	x		x	1 per 7 days
General characteristics	5.3.3				
Appearance	5.3.3.1	x	1 per year	x	1 per 8 h
Colour	5.3.3.2	x	1 per year	x	1 per 8 h
Opacity	5.3.3.3	x			
Classification of pipes	5.3.3.4	x			
Geometrical characteristics	5.3.4				
Length of pipes	5.3.4.1	x		x	1 per 8 h
Nominal outside diameters and wall thicknesses	5.3.4.2	x		x	1 per 8 h
Pipes with integral sockets with elastomeric sealing rings	5.3.4.3	x		x	1 per 8 h
Dimensions of pipe ends	5.3.4.4	x		x	1 per 8 h
Selection of pipes	5.3.5				
Selection of pipes	5.3.5	x			
Mechanical characteristics	5.3.6				
Resistance to internal (hydrostatic) pressure:	5.3.6.1				
- 10 h at 20°C		x	1 per year	x	1 per 7 days
- 1000 h at 60°C		x	1 per year		
Impact strength	5.3.6.2	x	1 per year	x	1 per 7 days
Physical characteristics	5.3.7				
Vicat softening temperature	5.3.7.1	x	1 per year		
Resistance to dichloromethane	5.3.7.2	x		x	1 per 24 h
Marking	5.3.8				
Marking of PVC-O drinking water pipes	5.3.8	x	1 per year	x	1 per 8 h

9.3 Test matrix for fittings with elastomeric sealing rings

Description of requirement	Clause BRL	Tests within the scope of:	
		Pre-certification	Control after issue of the certificate 1), 2)
Requirements fittings			
Toxicological requirements	4.2	x	x ³⁾
Rubber	6.2.1	x	x
Material - general	6.2.2.1	x	x
VCM content in material	6.2.2.2	x	x
Density	6.2.2.3	x	x
K value	6.2.2.4	x	x
Classification and verification of material	6.2.2.5	x	x
Appearance	6.2.3.1	x	x ³⁾
Colour	6.2.3.2	x	x
Opacity	6.2.3.3	x	x
Nominal diameter	6.2.4.2	x	x
Dimensions of fittings with elastomeric sealing rings	6.2.4.3	x	x ³⁾
Resistance to impact of fittings	6.2.5.1	x	x
Resistance to internal pressure of injection moulded fittings	6.2.5.2	x	x ³⁾
Resistance to internal pressure of couplers made from pipe or made by machining	6.2.5.3	x	x ³⁾
Vicat softening temperature	6.2.6.1	x	x ³⁾
Assessment of the effect of heating	6.2.6.2	x	x
Marking of elastomeric ring seal fittings	6.2.7	x	x ³⁾
Joint requirements			
Leaktightness under internal pressure and with angular deflection	4.8.1.1	x	-
Leaktightness under negative pressure	4.8.1.2	x	-

1. In case the product or production process changes significantly, the performance requirements shall be determined again.
2. During the inspection visit, the inspector shall check the product on the basis of a selection of the above listed requirements. The frequency of the inspection visits is recorded in clause 10.6 "Nature and frequency of external inspections".
3. Material is samples for an Audit Test by the inspector annually.

9.4 Test matrix of fittings for solvent cementing

Description of requirement	Clause BRL	Tests within the scope of:	
		Pre-certification	Control after issue of the certificate 1), 2)
Requirements fittings			
Toxicological requirements	4.2	x	x ³⁾
Glues	4.5	x	x
Glue instructions	6.3.1	x	x
Material - general	6.3.2.1	x	x
VCM content in material	6.3.2.2	x	x
Density	6.3.2.3	x	x
K value	6.3.2.4	x	x
Classification and verification of material	6.3.2.5	x	x
Appearance	6.3.3.1	x	x ³⁾
Colour	6.3.3.2	x	x
Opacity	6.3.3.3	x	x
Nominal diameter of fittings	6.3.4.2	x	x
Dimensions of fittings for solvent cementing	6.3.4.3	x	x ³⁾
Resistance to impact of fittings	6.3.5.1	x	x
Resistance to internal pressure of injection moulded fittings	6.3.5.2	x	x ³⁾
Vicat softening temperature	6.3.6.1	x	x ³⁾
Assessment of the effect of heating	6.3.6.2	x	x
Marking of elastomeric ring seal fittings	6.3.7	x	x ³⁾
Joint requirements			
Long-term leaktightness under internal pressure	4.8.1.3	x	-

1. In case the product or production process changes significantly, the performance requirements shall be determined again.
2. During the inspection visit, the inspector shall check the product on the basis of a selection of the above listed requirements. The frequency of the inspection visits is recorded in clause 10.6 "Nature and frequency of external inspections".
3. Material is samples for an Audit Test by the inspector annually .

9.5 Test matrix bends made from pipe

Description of requirement	Clause BRL	Tests within the scope of:	
		Pre-certification	Control after issue of the certificate 1), 2)
Toxicological requirements	4.2	x	x ³⁾
Rubber	4.4	x	x
Glues	4.5	x	x
General	6.4.1	x	x
Nominal diameter of bend	6.4.2.2	x	x
Permitted dimensional variation of the outside diameters and wall thicknesses at the ends	6.4.2.3	x	x ³⁾
Permitted dimensional variation of the outside diameters and wall at the location of the portion of the curve	6.4.2.4	x	x ³⁾
Angles	6.4.2.5	x	x ³⁾
Radius of curvature of bends	6.4.2.6	x	x ³⁾
Installation dimensions (Z lengths)	6.4.2.7	x	x ³⁾
Bend ends	6.4.3	x	x
Bends with sockets for solvent cementing	6.4.4	x	x
Resistance to impact	6.4.5.1	x	x
Resistance to internal pressure of injection moulded fittings	6.4.5.2	x	x ³⁾
Markings bends made from PVC-U drinking water pipes	6.4.6	x	x ³⁾

1. In case the product or production process changes significantly, the performance requirements shall be determined again.
2. During the inspection visit, the inspector shall check the product on the basis of a selection of the above listed requirements. The frequency of the inspection visits is recorded in clause 10.6 "Nature and frequency of external inspections".
3. Material is samples for an Audit Test by the inspector annually.

9.6 Test matrix saddles of PVC-U

Description of requirement	Clause BRL	Tests within the scope of:	
		Pre-certification	Control after issue of the certificate 1), 2)
Requirements fittings			
Toxicological requirements	4.2	x	x ³⁾
Material	7.2.2	x	x
Elastomeric rings	7.2.3	x	x
Appearance	7.2.4.1	x	x ³⁾
Colour	7.2.4.2	x	x
Opacity	7.2.4.3	x	x
Construction and design	7.2.5	x	x
Inside diameter of the saddle	7.2.6.2	x	x ³⁾
Wall thickness of the saddle	7.2.6.3	x	x ³⁾
Length of the saddle	7.2.6.4	x	x
Screw-thread in the saddle	7.2.7	x	x
Resistance to impact	7.2.8.1	x	x ³⁾
Resistance to internal pressure	7.2.8.2	x	x ³⁾
Strength of the screw thread	7.2.8.3	x	x
Resistance to compression	7.2.8.4	x	x
Vicat softening temperature	7.2.9.1	x	x ³⁾
Assessment of the effect of heating	7.2.9.2	x	x
Markings bends made from PVC-U drinking water pipes	7.2.10	x	x ³⁾
Joint requirements			
Leaktightness under internal pressure	4.8.2.1	x	-
Leaktightness under negative pressure	4.8.2.2	x	-
leaktightness under negative pressure and compression of the pipe	4.8.2.3	x	-

1. In case the product or production process changes significantly, the performance requirements shall be determined again.
2. During the inspection visit, the inspector shall check the product on the basis of a selection of the above listed requirements. The frequency of the inspection visits is recorded in clause 10.6 "Nature and frequency of external inspections".
3. Material is samples for an Audit Test by the inspector annually.

9.7 Test matrix end-load-bearing double sockets of PE and PVC

Description of requirement	Clause BRL	Tests within the scope of:	
		Pre-certification	Control after issue of the certificate 1), 2)
Requirements fittings			
Toxicological requirements	4.2	x	x ³⁾
General	7.3.1	x	x
Pipe material of PVC-U	7.3.2.1	x	x
Polyethylene material	7.3.2.2	x	x
Elastomeric sealing rings	7.3.3	x	x
Adhesive and cleaning products	7.3.4	x	x
Locking device	7.3.5	x	x
Metal parts	7.3.6	x	x
Appearance	7.3.6.1	x	x ³⁾
Colour	7.3.6.2	x	x
Opacity	7.3.6.3	x	x
Nominal diameter of the end-load-bearing couplers with elastomeric sealing rings	7.3.7.2	x	x
Dimensions of end-load-bearing fittings with elastomeric sealing elements	7.3.7.3	x	x
Dimensions of solvent cemented joints between PVC sleeve and pipe	7.3.7.4	x	x
Resistance to impact	7.3.8.1	x	x
Vicat softening temperature	7.3.9.1	x	x ³⁾
Oxidation induction time	7.3.9.2	x	x ³⁾
Assessment of the effect of heating	7.3.9.3	x	x
Markings end-load-bearing double sockets of PE and PVC	7.3.11	x	x ³⁾
Joint requirements			
Leaktightness and strength while subjected to bending and internal pressure	7.3.10.1	x	-
Long-term leaktightness under internal pressure	7.3.10.2	x	-

1. In case the product or production process changes significantly, the performance requirements shall be determined again.
2. During the inspection visit, the inspector shall check the product on the basis of a selection of the above listed requirements. The frequency of the inspection visits is recorded in clause 10.6 "Nature and frequency of external inspections".
3. Material is samples for an Audit Test by the inspector annually.

9.8 Test matrix for injection moulded PVC fittings with flange connections

Description of requirement	Clause BRL	Tests within the scope of:	
		Pre-certification	Control after issue of the certificate 1), 2)
Requirements fittings			
Toxicological requirements	4.2	x	x ³⁾
General	7.4.1	x	x
Material	7.4.2	x	x
Rubber	7.4.3	x	x
Appearance	7.4.4.1	x	x ^{o)}
Colour	7.4.4.2	x	x
Opacity	7.4.4.3	x	x
Nominal diameter of the fitting	7.4.5.2	x	x
Dimensions of the fittings	7.3.5.3	x	x
Dimensions of the flange connection	7.4.5.4	x	x
Impact resistance of fitting	7.4.6.1	x	x
Resistance to internal pressure	7.4.6.2	x	x
Markings end-load-bearing double sockets of PE and PVC	7.4.8	x	x ^{o)}
Joint requirements			
Strength and leaktightness of the flange connection	7.4.7.1	x	-

1. In case the product or production process changes significantly, the performance requirements shall be determined again.
2. During the inspection visit, the inspector shall check the product on the basis of a selection of the above listed requirements. The frequency of the inspection visits is recorded in clause 10.6 "Nature and frequency of external inspections".

Material is samples for an Audit Test by the inspector annually.

9.9 Inspection of the quality system of the supplier

The quality system of the supplier will be checked by Kiwa on the basis of the IQC scheme.

The inspection contains at least those aspects mentioned in the Kiwa Regulations for Certification.

10 Agreements on the implementation of certification

10.1 General

Beside the requirements included in these evaluation guidelines, the general rules for certification as included in the Kiwa Regulations for Product Certification also apply. These rules are in particular:

- the general rules for conducting the pre-certification tests, in particular:
 - the way suppliers are to be informed about how an application is being handled;
 - how the test are conducted;
 - the decision to be taken as a result of the pre-certification tests.
- the general rules for conducting inspections and the aspects to be audited,
- the measures to be taken by Kiwa in case of Non-Conformities,
- the measures taken by Kiwa in case of improper use of Certificates, Certification Marks, Pictograms and Logos,
- terms for termination of the certificate,
- the possibility to lodge an appeal against decisions of measures taken by Kiwa.

10.2 Certification staff

The staff involved in the certification may be sub-divided into:

- Certification assessor (**CAS**): in charge of carrying out the pre-certification tests and assessing the inspectors' reports;
- Site assessor (**SAS**): in charge of carrying out external inspections at the supplier's works;
- Decision maker (**DM**): in charge of taking decisions in connection with the pre-certification tests carried out, continuing the certification in connection with the inspections carried out and taking decisions on the need to take corrective actions.

10.2.1 Qualification requirements

The qualification requirements consist of:

- qualification requirements for personnel of a certification body which satisfies the requirements EN ISO / IEC 17065, performing certification activities
- qualification requirements for personnel of a certification body performing certification activities set by the Board of Experts for the subject matter of this evaluation guideline

Education and experience of the concerning certification personnel shall be recorded demonstrably.

Basic requirements	Evaluation criteria
Knowledge of company processes Requirements for conducting professional audits on products, processes, services, installations, design and management systems.	<i>Relevant experience: in the field</i> SAS, CAS : 1 year DM : 5 years inclusive 1 year with respect to certification Relevant technical knowledge and experience on the level of: SAS : High school CAS, DM : Bachelor
Competence for execution of site assessments. Adequate communication skills (e.g. reports, presentation skills and interviewing technique).	SAS : Kiwa Audit training or similar and 4 site assessments including 1 autonomic under review.

Basic requirements	Evaluation criteria
Execution of initial examination	CAS: 3 initial audits under review.
Conducting review	CAS: conducting 3 reviews

Technical competences	Evaluation Criteria
Education	General: Education in one of the following technical areas: <ul style="list-style-type: none"> • Civil Engineering; • Engineering.
Testing skills	General: <ul style="list-style-type: none"> • 1 week laboratory training (general and scheme specific) including measuring techniques and performing tests under supervision ; • Conducting tests (per scheme).
Experience - specific	CAS <ul style="list-style-type: none"> • 3 complete applications (excluding the initial assessment of the production site) under the direction of the PM • 1 complete application self-reliant (to be evaluated by PM) • 3 initial assessments of the production site under the direction of the PM • 1 initial assessment of the production site self-reliant (witnessed by PM) SAS <ul style="list-style-type: none"> • 5 inspection visits together with a qualified SAS • 3 inspection visits conducted self-reliant (witnessed by PM)
Skills in performing witnessing	PM Internal training witness testing

Legenda:

- Certification assessor (**CAS**)
- Decision maker (**DM**)
- Product manager (**PM**)
- Site assessor (**SAS**)

10.2.2 Qualification

The qualification of the Certification staff shall be demonstrated by means of assessing the education and experience to the above mentioned requirements. In case staff is to be qualified on the basis of deflecting criteria, written records shall be kept.

The authority to qualify staff rests with the:

- **PM:** qualification of **CAS** and **SAS**;
- management of the certification body: qualification of **DM**.

10.3 Report initial investigation

The certification body records the results of the initial investigation in a report.

This report shall comply with the following requirements:

- completeness: the report provides a verdict about all requirements included in the evaluation guideline;

- traceability: the findings on which the verdicts have been based shall be recorded and traceable;
- basis for decision: the **DM** shall be able to base his decision on the findings included in the report.

10.4 Decision for granting the certificate

The decision for granting the certificate shall be made by a qualified Decision maker which has not been involved in the pre-certification tests. The decision shall be recorded in a traceable manner.

10.5 Layout of quality declaration

The product certificate shall be in accordance with the model included in the Annex.

10.6 Nature and frequency of third party audits

The certification body shall carry out surveillance audits on site at the supplier at regular intervals to check whether the supplier complies with his obligations. The Board of Experts decides on the frequency of audits.

At the time this BRL entered into force, the frequency of audits amounts two audit(s) on site per year for suppliers with a quality management system in accordance with ISO 9001 for their production, which has been certified by an acknowledged body (in accordance with ISO/IEC 17021) and where the IQC scheme forms an integral part of the quality management system.

In case the supplier is not in possession of any product certificate (issued by Kiwa or any other accredited certification body), the frequency is increased to four visits for the duration of one year.

The audit program on site shall cover at least:

- the product requirements;
- the production process;
- the suppliers IQC scheme and the results obtained from inspections carried out by the supplier;
- the correct way of marking certified products;
- compliance with required procedures;
- handling complaints about products delivered.

For suppliers with a private label certificate the frequency of audits amounts to one audit per two years. These audits are conducted at the site of the private label certificate holder. The audits are conducted at the site of private label holder and focussed on the aspects inserted in the IQC scheme and the results of the control performed by the private label holder. The IQC scheme of the private label holder shall refer to at least:

- the correct way of marking certified products;
- compliance with required procedures for receiving and final inspection;
- the storage of products and goods;
- handling complaints.

The results of each audit shall be recorded by Kiwa in a traceable manner in a report.

10.7 Non conformities

When the certification requirements are not met, measures are taken by Kiwa in accordance with the sanctions policy as written in the Kiwa Regulation for Certification.

The Sanctions Policy is available through the "News and Publications" page on the Kiwa website ["Kiwa Regulation for Certification"](#).

10.8 Report to the Board of Experts

De certification body shall report annually about the performed certification activities. In this report the following aspects are included:

- mutations in number of issued certificates (granted/withdrawn);
- number of executed audits in relation to the required minimum;
- results of the inspections;
- required measures for established Non-Conformities;
- received complaints about certified products.

10.9 Interpretation of requirements

The Board of Experts may record the interpretation of requirements of this evaluation guideline in one separate interpretation document.

11 Titles of standards

11.1 Public law rules

Standard	Title
Staatscourant van 21 april 2017 nr. 20932	Regeling Materialen en Chemicaliën drink- en warm tapwatervoorziening

11.2 Standards / normative documents

Number	Title	Version*
ISO 3	Preferred numbers - Series of preferred numbers	
ISO 497	Guide to the choice of series of preferred numbers and of series containing more rounded values of preferred numbers	
ISO 3127	Thermoplastics pipes - Determination of resistance to external blows - Round-the-clock method	
ISO 4065	Thermoplastics pipes - Universal wall thickness table	
NEN-EN 727	Plastics piping and ducting systems - Thermoplastics pipes and fittings - Determination of Vicat softening temperature (VST)	
NEN-EN 805	Watervoorziening - Eisen aan distributiesystemen buitenshuis	
NEN-EN 806	Eisen voor drinkwaterinstallaties in gebouwen	
NEN 1006	General requirements for water supply installations	
NEN-EN 10226-2	Pipe threads where pressure tight joints are made on the threads - Part 2: Taper external threads and taper internal threads - Dimensions, tolerances and designation	
NEN-EN 12061	Plastics piping systems - Thermoplastics fittings - Test method for impact resistance	
NEN-EN 12107	Plastics piping systems - Injection-moulded thermoplastics fittings, valves and ancillary equipment - Determination of the long-term hydrostatic strength of thermoplastics materials for injection moulding of piping components	
NEN-EN 12201-1	Plastics piping systems for water supply, and for drainage and sewerage under pressure - Polyethylene (PE) - Part 1: General	
NEN-EN 12201-3	Plastics piping systems for water supply, and for drainage and sewerage under pressure - Polyethylene (PE) - Part 3: Fittings	
NEN-EN 12294	Plastics piping systems - Systems for hot and cold water - Test method for leaktightness under vacuum	
NEN-EN 17176-1	Kunststofleidingssystemen voor watervoorziening en voor bovengrondse en ondergrondse drainage, drukriolering en irrigatie onder druk - Georiënteerde ongeplasticiseerde poly(vinylchloride) (PVC-O) - Deel 1: Algemeen	
NEN-EN 17176-2	Kunststofleidingssystemen voor watervoorziening en voor bovengrondse en ondergrondse drainage, drukriolering en irrigatie onder druk - Georiënteerde ongeplasticiseerde poly(vinylchloride) (PVC-O) - Deel 2: Buizen	
NEN-EN 45011	General requirements for bodies operating product certification systems	

NEN-EN-ISO 580	Plastics piping and ducting systems - Injection-moulded thermoplastics fittings - Methods for visually assessing the effects of heating
NEN-EN-ISO 1167-1	Thermoplastics pipes, fittings and assemblies for the conveyance of fluids - Determination of the resistance to internal pressure - Part 1: General method
NEN-EN-ISO 1167-2	Thermoplastics pipes, fittings and assemblies for the conveyance of fluids - Determination of the resistance to internal pressure - Part 2: Preparation of pipe test pieces
NEN-EN-ISO 1167-3	Thermoplastics pipes, fittings and assemblies for the conveyance of fluids - Determination of the resistance to internal pressure - Part 3: Preparation of components
NEN-EN-ISO 1167-4	Thermoplastics pipes, fittings and assemblies for the conveyance of fluids - Determination of the resistance to internal pressure - Part 4: Preparation of assemblies
NEN-EN-ISO 1183-1	Plastics - Methods for determining the density of non-cellular plastics - Part 1: Immersion method, liquid pycnometer method and titration method
NEN-EN-ISO 1452-1	Plastics piping systems for water supply and for buried and above-ground drainage and sewerage under pressure - Unplasticized poly(vinyl chloride) (PVC-U) - Part 1: General
NEN-EN-ISO 1452-2	Plastics piping systems for water supply and for buried and above-ground drainage and sewerage under pressure - Unplasticized poly(vinyl chloride) (PVC-U) - Part 2: Pipes
NEN-EN-ISO 1452-3	Plastics piping systems for water supply and for buried and above-ground drainage and sewerage under pressure - Unplasticized poly(vinyl chloride) (PVC-U) - Part 3: Fittings (corrected and reprinted)
NEN-EN-ISO 1452-5	Plastics piping systems for water supply and for buried and above-ground drainage and sewerage under pressure - Unplasticized poly(vinyl chloride) (PVC-U) - Part 5: Fitness for purpose of the system
NEN-EN-ISO 2505	Thermoplastics pipes - Longitudinal reversion - Test method and parameters
NEN-EN-ISO 3126	Plastics piping systems - Plastics components - Determination of dimensions
NEN-EN-ISO 6401	Plastics - Poly(vinyl chloride) - Determination of residual vinyl chloride monomer - Gas-chromatographic method
NEN-EN-ISO 7686	Plastics pipes and fittings - Determination of opacity
NEN-EN-ISO 9001	Quality management systems - Requirements
NEN-EN-ISO 9080	Plastics piping and ducting systems - Determination of the long-term hydrostatic strength of thermoplastics materials in pipe form by extrapolation
NEN-EN-ISO 11357-6	Plastics - Differential scanning calorimetry (DSC) - Part 6: Determination of oxidation induction time (isothermal OIT) and oxidation induction temperature (dynamic OIT)
NEN-EN-ISO 12162	Thermoplastics materials for pipes and fittings for pressure applications - Classification, design coefficient and designation
NEN-EN-ISO 13229	Thermoplastics piping systems for non-pressure applications - Unplasticized poly(vinyl chloride) (PVC-U) pipes and fittings - Determination of the viscosity number and K-value
NEN-EN-ISO 13783	Plastics piping systems - Unplasticized poly(vinyl chloride) (PVC-U) end-load-bearing double socket joints -

	Test method for leaktightness and strength while subjected to bending and internal pressure
NEN-EN-ISO 13844	Plastics piping systems - Elastomeric-sealing-ring-type socket joints of unplasticized poly(vinyl chloride) (PVC-U) for use with PVC-U pipes - Test method for leaktightness under negative pressure
NEN-EN-ISO 13845	Plastics piping systems - Elastomeric-sealing-ring-type socket joints for use with unplasticized poly(vinyl chloride) (PVC-U) pipes - Test method for leaktightness under internal pressure and with angular deflection
NEN-EN-ISO 13846	Plastics piping systems - End-load-bearing and non-end-load-bearing assemblies and joints for thermoplastics pressure piping - Test method for long-term leaktightness under internal water pressure
NEN-ISO 5893	Rubber and plastics test equipment - Tensile, flexural and compression types (constant rate of traverse) - Specification
NEN-EN-ISO/IEC 17020	Conformity assessment - General criteria for the operation of various types of bodies performing inspection
NEN-EN-ISO/IEC 17021	Conformity assessment - Requirements for bodies providing audit and certification of management system
NEN-EN-ISO/IEC 17024	Conformity assessment - General requirements for bodies operating certification of persons
NEN-EN-ISO/IEC 17025	General requirements for the competence of testing and calibration laboratories
NEN-EN ISO/IEC 17065	Conformity assessment - Requirements for bodies certifying products, processes and services
NPR-CEN/TS 1452-7	Plastics piping systems for water supply - Unplasticized poly(vinyl chloride) (PVC-U) - Part 7: Guidance for the assessment of conformity
CEN/TS 17176-7	Plastics piping systems for water supply and for buried and above ground drainage, sewerage and irrigation under pressure - Oriented unplasticized poly(vinyl chloride) (PVC-O) - Part 7: Assessment of conformity

*) The documents in this table, in whole or in part, are normatively referenced in this document. For dated references, only the edition cited applies. For undated references, the latest edition of the reference document (including any amendments) applies.

Note: Within the text, references to specific clauses, tables and figures of another document shall always be dated.

I Model certificate (example)

	Product certificate KXXXXXX/0X	
	Issued Replaces Page 1 of 1	
CERTIFICATE	Name product	
	STATEMENT BY KIWA With this product certificate, issued in accordance with the Kiwa Regulations for Certification, Kiwa declares that legitimate confidence exists that the products supplied by	
	Name customer	
	as specified in this product certificate and marked with the Kiwa®-mark in the manner as indicated in this product certificate may, on delivery, be relied upon to comply with Kiwa evaluation guideline BRL-xxxx "xxxxxxxxxxxxxxxxxxxxxxxx" dated [dd-mm-yyyy] inclusive amendment sheet dated dd-mm-yyyy.	
	 Luc Leroy Kiwa	
	<i>Publication of this certificate is allowed. Advice: consult www.kiwa.nl in order to ensure that this certificate is still valid.</i>	
Kiwa Nederland B.V. Sir Winston Churchilllaan 273 P.O.Box 70 2280 AB RUISWIJK The Netherlands Tel. +31 88 998 44 00 Fax +31 88 998 44 20 info@kiwa.nl www.kiwa.nl	Company Name customer Address customer Phone number Fax number www. Email	<div style="border: 1px solid black; padding: 5px;"><p>Certification process consists of initial and regular assessment of:</p><ul style="list-style-type: none">• quality system• product</div>

140410

II Model IQC-scheme (example)

Inspection subjects	Inspection aspects	Inspection method	Inspection frequency	Inspection registration
Raw materials or materials supplied: - recipe sheets - incoming goods inspection raw materials	- Recipe according annex product certification agreement - K-value - Vicat	Comparison supplier's certificate with agreement - -	Each delivery Each delivery	Incoming inspection document
Production process, production equipment, plant: - procedures - working instructions - equipment - release of product	- start up parameters - maintenance aspects - dimensions - soundness	- the focus of the production equipment - maintenance scheme - measuring - visual evaluation	- continuously - continuously - start up new product	- "digital" - record - inspection document
Finished-products	- soundness - dimensions - resistance to internal pressure - resistance MCL	- visual - measuring - - visual	- continuously - every 3 hours - per day per product per machine	Final inspection documents
Measuring and testing equipment - measuring equipment - calibration	- good functioning - accuracy within the field of activity	-during use - recording of nonconformities	- continuously - once per year	- final inspection document - calibration document
Logistics - internal transport - storage - preservation - packaging - identification or marking of semi-finished and finished products	- Practical circumstances - comparison with assignment	- Comparison with procedure - visual inspection	- continuously	- update of logistical procedures

III Maximum allowable operating pressure (PFA) and de-rating factors

(normative)

On the basis of situations that can be expected in practice, it must be taken into account that for PVC-U pipes a difference must be made between the nominal pressure as indicated on the pipes and the maximum allowable working pressure in the piping system. Limiting factors which determine the permissible working pressure, occur in situations where pipes are exposed to external loads, or chemical or thermal influences. For external loads and chemical influences no uniform derating factors can be given. These must be determined for each case on the basis of practical experiences. In situations where thermal influence exists, it is advised to follow table III,1 For a more accurate approach, NEN-EN-ISO 1452-2:2009, figure A.1 can be taken into account.

For water temperatures up to 25 ° C: $PFA = PN$
 For water temperatures above 25 ° C: $PFA = f_T \times PN$

in which:

f_T is the derating factor, which depends on the water temperature
 PN is nominal pressure.

In cases where a derating factor is required for the application: $PFA = f_A \times f_T \times PN$, where f_A is the derating factor for the application.

Table III.1 – Derating factors for the calculation of the maximum allowable working pressure in PVC-U pipes at higher services temperature.

Temperature of the pipe wall °C		Derating factor (f_T)
Higher than	up to and including	
10	25	1,00
25	35	0,80
35	45	0,63

The scope of PVC-U pipes is limited to a temperature of 45 ° C.

IV Design coefficient

(normative)

The design coefficient C is a factor that is needed for the calculation of the design stress σ_s for pipes which are intended to be used with internal pressure by:

$$\sigma_s = \frac{MRS}{C};$$

where MRS is the minimum required strength.

From the calculated value of σ_s and the S value of the pipe, the nominal pressure PN can be calculated:

$$PN = \frac{\sigma_s}{S} = \frac{20 \times MRS}{C \times (SDR-1)};$$

where:

PN is the nominal pressure is expressed in bar;

MRS is the minimum required strength expressed in MPa;

C is design coefficient;

SDR is the standard dimension ratio = d_n / e_n and;

S is the S -value of the pipe.

$$S = \frac{SDR-1}{2} = \frac{d_n - e_n}{2 \times e_n};$$

where:

d_n is the nominal diameter;

e_n is nominal wall thickness.

In recent years, the production of PVC-U pipes significantly improved, which resulted in an improved impact resistance and reduced susceptibility to brittle fracture. Therefore, the design coefficient for PVC-U pipes reduced from 2.5 to 2.0.

Bi-axially oriented pipes PVC-O have a better resistance to crack initiation in applications under internal pressure than PVC-U pipes. The molecular process that underlies brittle fracture growth is suppressed by orientation. At an orientation of 1,6, this is even completely suppressed thereby lowering the design coefficient to $C = 1,6$ is permitted.

Note 1: The selected design coefficient C value of 1,6 is the recommended minimum in accordance with NEN-EN-ISO 12162.

Note 2: In case of plastics, it is common practice to evaluate the material at 20 °C. On the basis of this temperature, the design coefficient C set. The current operating temperature of pipes in the ground for the transport of drinking water in the Netherlands is assumed to be 10 °C. Consequently, the expected lifetime are significantly longer.

V Guidance for prevention of contamination during transport and storage of new products

(informative)

Importance of a hygienic operation

Hygiene and hygienic work is since decades an important issue with respect to the transport and distribution of drinking water in the Netherlands.

The impact of pollution can have big consequences for the water distribution¹⁾ and need substantial efforts to clean the system, especially because in the Netherlands chlorine is not used. Already in the 1983 published "guideline for installation of PVC-U piping systems, paragraph 4.2 "Storage", mentions this topic as follows: *For the prevention and risk of difficulties disinfecting of the pipe line afterwards, it is recommended to use plugs in pipe ends for storage of the pipes.*

The importance of hygiene also reflected in recent documents e.g. Dutch Hygiene code: "Hygiëncode Drinkwater; Opslag, transport en distributie" with the accompanying work instructions ("werkboekje") for mechanics. As result of the Hygiene code a wide range of courses for parties involved (installers, personnel of water companies, etc.) can be followed. Last but not least the Hygiene code is also mentioned in the drinking water law of July 1, 2011 and is therefore part of the Dutch law.

Protection of the products during storage and transport

In the "Hygiëncode Drinkwater: Opslag, transport en distributie" with the accompanying work instructions for mechanics the aspect how to work hygienically is extensively described. It involves dealing with parts for piping systems (pipes, fittings, valves and hydrants) starting with the arrival of the parts at the construction site to the realization and commissioning of the pipeline. The primary approach to hygienic work is "prevention". Secondly, there are measures described in order to make pipelines suitable for the delivery of clear drinking water. The hygiene aspects in the process from the manufacture of the product in the factory, assembly hall or other production location are briefly described in the "Hygiëncode Drinkwater". Also in this process is the primary approach prevention: For each product applies the sooner the product is protected against contamination²⁾, the better the hygiene of the product can be guaranteed. To close the hygiene chain completely and to be eligible for certification, producers of part for piping systems for drinking water shall have a procedure in which measures are described for storage and the route to the water companies (delivery address), as will be defined in general terms or laid down in relevant Kiwa evaluation guidelines. The producer shall have a procedure for the protection of the products during transport and storages, to be able to guarantee that hygiene requirements are meet.

Note:

- 1) Mostly this is a microbiological contamination coming from the surrounding area on macro- and micro scale like dust, but also faeces and dead beasts.
- 2) In this context the word "protection" is used as a combination of packing (e.g. providing the product with a casing) and, when applicable, providing end caps (e.g. for pipes and fittings).

Requirements for the protection

For all preventive (protective) actions taken to protect the products against pollution, it is important that the protection is sufficient during the complete process starting after production of the product (followed by e.g. storage, transport and again storage) and ending with the installation of the products.

Capabilities to protect the product:

The used packaging depends on the product itself (shape, dimensions, etc.)

Some packaging solutions (not binding and not exhaustive) are mentioned below:

- For small fittings (couplings, rings, rubber seals) a plastic bag eventually in a box;
- "Bubble wrap" foil in combination with adhesive tape for all openings for big(ger) fittings;
- The combination of bags made of fiber reinforced material or heat shrink foil and the use of a box for smaller part;
- End-caps / plugs or stern plastics bags for the pipe ends (where the complete pipe package is wrapped in foil).

In 2007 representatives of the manufacturers and the water companies organized in the commission 'OnderhandelingsCommissie Kunststoffen' (OCK) started a project to improve the quality of packaging.

The project resulted in the following construction of end-capes for pipes.

The end cap is unmovable fixed in the pipe by using flaps in a labyrinth structure to let in air but prevent pollution.

The end cap is developed for a 110 mm PVC pipe but can also be developed for other diameters (50, 63, 75, 90, 160, 200 and 250 mm), and for all used pipe materials.

For closing pipe ends with a diameter of 315, 400, 500 and 630 mm a fiber reinforced cover in combination with adhesive tape or lashing straps can be used (see the pictures below).

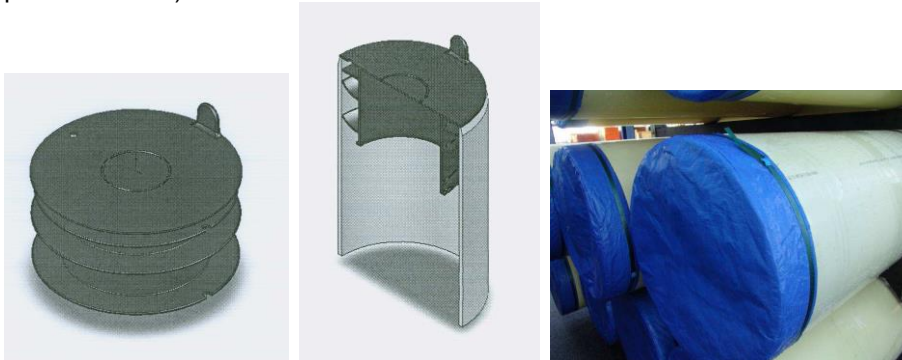

Left: end cap with flaps. Right: fiber reinforced cover in combination with adhesive tape.

Mess bags cannot be sealed against dust and dirt, and for this reason are not recommended as the only packaging for small parts.

VI Comparison of standards

(informative)

PVC-U Pipes

Description of requirement	Article no. of BRL	NEN-EN-ISO 1452-1: 2009	NEN-EN-ISO 1452-2: 2019	Comparison
General	5.1			
Toxicological requirements	4.2	4.2		Different
Rubber sealing	4.4		10	Different
Adhesive sealing	4.5		11	Different
PVC-U Pipes	5.2			
Material	5.2.1			
General requirements	5.2.1.1	4.1		Identical
VCM content	5.2.1.1	4.1		Identical
K-value	5.2.1.2	-	-	Additional
Use of non-virgin material	5.2.1.3	4.3		Additional
Density	5.2.1.4		4.2	Identical
Classification and verification	5.2.1.5	4.4.1 & 4.4.2	4.3	Identical
MRS value	5.2.1.5	4.4.1 & 4.4.2	4.3	Identical
General characteristics	5.2.2			
Appearance	5.2.2.1		5.1	Identical
Colour	5.2.2.2		5.2	Different
Opacity	5.2.2.3		5.3	Identical
Geometrical characteristics	5.2.3			
Nominal outside diameter and tolerances	5.2.3.1		6.2	Identical
Mean outside diameter and tolerances	5.2.3.2		6.3	Identical
Wall thickness and their tolerances	5.2.3.3		6.4	Identical
Length of pipe	5.2.3.4		6.5	Identical
Dimensions of pipes with integral sockets for solvent cementing joints	5.2.3.5		6.6.1	Additional
Dimensions of pipes with integral sockets with rubber sealing rings type joints	5.2.3.6		6.6.2	Identical
Dimensions of pipe ends	5.2.3.7		6.7	Different
Classification and selection of the pipes	5.2.4			
Classification and selection of the pipes	5.2.4		7	Identical + annex IV
Mechanical characteristics	5.2.5			
Impact strength	5.2.5.1		8.1	Additional
Resistance to internal pressure	5.2.5.2		8.2	Additional
Physical characteristics	5.2.6			
Vicat softening temperature	5.2.6.1		9	Additional
Longitudinal reversion	5.2.6.2		9	Additional
Resistance to dichloromethane	5.2.6.3		9	Note
Marking of PVC-U drinking water pipes	5.2.7			
Marking of PVC-U drinking water pipes	5.2.7		13	Different

PVC-O pipes

Description of requirement	Article no. of BRL	NEN-EN 17176-1: 2009	NEN-EN 17176-2: 2019	Comparison
General	5.1			
Toxicological requirements	4.2	5.2		Different
Rubber sealing	4.4		11	Different
Adhesive sealing	4.5		12	Different
PVC-O Pipes	5.3			
Work instructions	5.3.1			Different
Material	5.3.2			
VCM content	5.3.2.1	5.1		Identical
K value	5.3.2.1	5.1		Different
Use of non-virgin material	5.3.2.2	5.3		Additional
Density	5.3.2.3		5.2	Identical
MRS value	5.3.2.4	6.1	5.3	Identical
Design stress	5.3.2.5	6.3		Identical
Orientation factors	5.3.2.6		5.4	Additional
General characteristics	5.3.3			
Appearance	5.3.3.1		6.1	Identical
Colour	5.3.3.2		6.2 a)	Different
Opacity	5.3.3.3		6.3	Identical
Classification of pipes	5.3.3.4		6.4	Identical
Geometrical characteristics	5.3.4		7.1	Identical
Length of pipes	5.3.4.1		7.2	Identical
Nominal outside diameters and wall thicknesses	5.3.4.2		7.3	Identical
Pipes with integral sockets with elastomeric sealing rings	5.3.4.3		7.4	Identical
Dimensions of pipe ends	5.3.4.4		7.5 & 7.6	Different
Selection of pipes	5.3.5			
Selection of pipes	5.3.5		8	Identical
Mechanical characteristics	5.3.6			
Resistance to internal (hydrostatic) pressure	5.3.6.1		9.1	Different
Impact strength	5.3.6.2		9.2	Additional
Ring stiffness	-		9.3	Different
Physical characteristics	5.3.7			
Vicat softening temperature	5.3.7.1		10	Identical
Resistance to dichloromethane	5.3.7.2		10	Note
Marking	5.3.8			
Marking of PVC-O drinking water pipes	5.3.8		13	Different