

BRL-K17105
2017-10-03
Amendment
2023-04-21

Evaluation Guideline

for the Kiwa product certificate for plastics piping
systems of polyethylene for the transport of
drinking water and raw water



Preface Kiwa

This evaluation guideline has been prepared by the Kiwa Board of Experts Water Cycle (CWK), wherein all the relevant parties in the field of plastics piping systems of polyethylene for the transport of drinking water and raw water are represented. These Boards of Experts also supervises the certification activities and where necessary require the evaluation guideline to be revised. Wherever the term "Board of Experts" is written in this evaluation guideline, the above mentioned Board of Experts is meant.

This evaluation guideline will be used by Kiwa in conjunction with the Kiwa Regulations for Product certification. This regulation details the method employed by Kiwa for conducting the necessary investigations prior to issuing the product certificate and the method of external control.

The product requirements and test methods for the polyethylene parts are based on NEN-EN 12201, parts 1, 2,3 and 5 and NPR-CEN/TS 12201-7. This evaluation guideline contains additional requirements and test methods set by the Board of Experts

Kiwa Nederland B.V.

Sir Winston Churchillaan 273
Postbus 70
2280 AB RIJSWIJK
The Netherlands

Tel. +31 70 414 44 00
Fax +31 70 414 44 20
info@kiwa.nl
www.kiwa.nl

© 2017 Kiwa N.V.

All rights reserved. No part of this report may be reproduced, stored in a database or retrieval system, or published, in any form or in any way, electronically, mechanically, by print, photoprint, microfilm or any other means without prior written permission from the publisher.

The use of this evaluation guideline by third parties, for any purpose whatsoever, is only allowed after a written agreement is made with Kiwa to this end.

Validation

This evaluation guideline has been validated by the Director Certification and Inspection of Kiwa on 2017-10-03.

Amendment BRL K17105

Plastics piping systems of polyethylene for the transport of drinking water and raw water

Date amendment sheet: Review 2022-08-23

Approved by the Board of Experts CWK d.d. 1 August 2022

General

The use of this amendment by third parties, no matter the purpose, is only permitted after a written agreement has been concluded with Kiwa regulating the right of use.

Validity

This amendment belongs to BRL K17105 dated 03-10-2017.

The product certificates issued based on that evaluation guideline do not lose their validity.

Binding declaration

This amendment is declared binding by Kiwa on 21-04-2023.

Description of the change

Changes due to new Kiwa BRL template are made in the following articles:

- Preface
- 2 Terminology
- 3 Procedure for granting a product certificate
- 10.5 Inspection of the quality system

Requirements for PVC-U fittings:

- 6.2.2 PVC-U as described below is modified,
- 6.5 Table 9, requirements for PVC-U as described below is added,
- 10.3 Table 16, test matrix: Vicat softening temperature (for PVC-U) as described below is added.

Requirements for metal fittings:

- 6.6 Table 10 is replaced.

Requirements for PVC-U saddles:

- WB 7 as described below is added.

Titles of standards is updated:

- 12.2 is extended as described below.

New model certificate:

- Annex I *Model certificate* must be replaced as described below.

Preface

The Kiwa Regulations for Product certification is replaced by the Kiwa Regulations for Certification.

2 Terminology

Additional definitions:

- **Certification mark:** a protected trademark of which the authorization of the use is granted by Kiwa, to the supplier whose products can be considered to comply on delivery with the applicable requirements
- **Drinking water:** water intended or partly intended for drinking, cooking or food preparation or other domestic purposes, but does not include hot water, and is made available by pipeline to consumers or other customers.
- **Installation:** configuration consisting the pipe work, fittings and appliances;
- **Pre-certification tests** is replaced by **Initial investigation:** tests in order to ascertain that all the requirements recorded in the evaluation guideline are met.
- **IQC scheme (IQCS):** a description of the quality inspections carried out by the supplier as part of his quality system.
- **Private Label Certificate:** A certificate that only pertains to products that are also included in the certificate of a supplier that has been certified by Kiwa, the only difference being that the products and product information of the private label holder bear a brand name that belongs to the private label holder.

3 Procedure for granting a product certificate

In the title *the quality declaration* is replaced by *a product certificate*.

The whole chapter should be replaced by:

3.1 Initial investigation

The initial investigation to be performed are based on the (product) requirements as contained in this evaluation guideline, including the test methods, and comprises the following:

- type testing to determine whether the products comply with the product and/or functional requirements;
- production process assessment;
- assessment of the quality system and the IQC-scheme;
- assessment on the presence and functioning of the remaining procedures.

3.2 Granting the product certificate

After finishing the initial investigation, the results are presented to the Decision maker (see 11.4) deciding on granting the certificate. This person evaluates the results and decides whether the certificate can be granted or if additional data and/or tests are necessary.

3.3 Investigation into the product and/or performance requirements

Kiwa will investigate the to be certified products against the certification requirements as stated in the certification requirements.

The necessary samples will be drawn by or on behalf of Kiwa.

3.4 Production process assessment

When assessing the production process, it is investigated whether the producer is capable of continuously producing products that meet the certification requirements.

The evaluation of the production process takes place during the ongoing work at the producer.

The assessment also includes at least:

- The quality of raw materials, half-finished products and end products;
- Internal transport and storage.

3.5 Contract assessment

If the supplier is not the producer of the products to be certified, Kiwa will assess the agreement between the supplier and the producer.

This written agreement, which is available for Kiwa, includes at least:

- Accreditation bodies, scheme managers and Kiwa will be given the opportunity to observe the certification activities carried out by Kiwa or on behalf of Kiwa at the producer.

6 Product requirements and test methods: Fittings for mechanical joints

6.2.2 Plastics

The first paragraph and note shall be **modified** as follows:

Raw material(s) e.g. PP-H, PP-R, PP-B, POM homopolymer, POM copolymer of the fitting body shall comply to the requirements specified in table 7. **PVC-U shall comply to the requirements specified in BRL K17301.**

Note: For example (e.g.) is used here to prevent exclusion of **innovative** products **made of other plastics**. Suppliers of **innovative** products **made of other plastics** shall demonstrate that the products fulfil the requirements of BRL-K17105.

6.5 Physical and mechanical requirements plastic fittings

Table 9: The table shall be **modified** as follows:

MRS value	...																			
Effect of heating	The maximum dimensions of cracks, delamination, blisters weld-line openings, damage around the sprue point shall be < 30 % relative to the wall thickness of the product.	Test parameters (temperature and duration of heating) in accordance with the relevant product standard and as recorded in the IQC scheme. For PP (150 ± 2) °C and at least 60 minutes. For POM (160 ± 2) °C and at least 60 minutes. For PVC-U (150 ± 2) °C and Test period for: <table border="1" style="margin-left: 20px;"> <tr> <td>e ≤ 3</td> <td>15 min</td> </tr> <tr> <td>3 < e ≤ 10</td> <td>30 min</td> </tr> <tr> <td>10 < e ≤ 20</td> <td>60 min</td> </tr> <tr> <td>20 < e ≤ 30</td> <td>140 min</td> </tr> <tr> <td>30 < e ≤ 40</td> <td>220 min</td> </tr> <tr> <td>40 < e</td> <td>240 min</td> </tr> </table>						e ≤ 3	15 min	3 < e ≤ 10	30 min	10 < e ≤ 20	60 min	20 < e ≤ 30	140 min	30 < e ≤ 40	220 min	40 < e	240 min	NEN-EN-ISO 580
e ≤ 3	15 min																			
3 < e ≤ 10	30 min																			
10 < e ≤ 20	60 min																			
20 < e ≤ 30	140 min																			
30 < e ≤ 40	220 min																			
40 < e	240 min																			
Vicat softening temperature	≥ 74°C	Shall conform to NEN-EN-ISO 2507-2						NEN-EN-ISO 2507-1												
Resistance to internal pressure	No failure during test period of any test piece	End caps	A				NEN-EN-ISO 1167 series													
		Number of test pieces	3																	
		Test type	Water-in-water																	
		POM																		
		Homopolymer fittings			Copolymer fittings															
		T (°C)	t (h)	p_T (bar)	T (°C)	t (h)	p_T (bar)													
		20	1	6,3 x PN	20	100	5,0 x PN													
		60	1000	1,5 x PN	60	1000	0,9 x PN													
					95	400	0,95 x PN													
		PP fittings																		
Type		T (°C)	t (h)		p_T (bar)															
PP-H		20	1		3,3 x PN															
		60	1000		0,9 x PN															
		95	1000		0,55 x PN															
PP-B		20	1		2,5 x PN															
		80	3000		0,75 x PN															

			95	1000	0,4 x PN
		PP-R	20	1	2,5 x PN
			80	3000	0,7 x PN
			95	1000	0,55 x PN
PE fittings					
		Type	T (°C)	t (h)	σ (MPa) ¹⁾
		PE80	20	100	10,0
			80	165	4,5
			80	1000	4,0
		PE100	20	100	12,0
			80	165	5,4
			80	1000	5,0
PVC-U fittings					
			T (°C)	t (h)	σ (MPa) ¹⁾
			20	1	42,0
			60	1000	10,0
MFR for PE fittings of: PE40; PE80; PE100			

6.6 Other requirements of metal fittings

Table 10: Should be replaced with:

Table 10 - Additional requirements of metal fittings

Characteristics	Requirement	Test parameter	Test method
Material fitting body	NEN-EN1254-3 NEN-EN 1254-6 NEN-EN 1254-8	As recorded in the IQC scheme	Information manufacturer
Rubber	BRL K17504	BRL K17504	BRL K17504
Dimensions	NEN-EN1254-3 NEN-EN 1254-6 NEN-EN 1254-8	Minimum thickness	Fitting body: NEN-EN 1254-3; Pipe threads: ISO 7-1 and NEN-EN-ISO 228-1
Construction	NEN-EN1254-3 NEN-EN 1254-6 NEN-EN 1254-8	Construction drawings	NEN-EN-ISO 3126
Resistance to inner water pressure (strength fitting body)	No cracks	NEN-EN1254-3 par. 5.1 NEN-EN 1254-6 par. 5.1.4 NEN-EN 1254-8 par.5.1.1	NEN-EN-ISO 1167-1
Resistance to stress corrosion	No cracks	PH 9,5	NEN-ISO 6957

WB 7 Requirements and test methods: PVC-U saddles

New chapter, inserted between chapter 7 and chapter 8

The saddles are intended for assembly with PE drinking water pipes according to BRL K17105 §5.

The Saddles of PVC-U have to comply with:

- General requirements and test methods BRL K17301;
- Requirements for joints: Saddles of PVC-U BRL K17301;
- Product requirements and test methods for special fittings: Saddles of PVC-U BRL K17301.

10 Summary of tests and inspections

10.3 Test matrix – Fittings for mechanical joint

Table 16: The following row should be **added**:

Effect of heating	table 9	x	x
Vicat softening temperature	table 9	x	x ³⁾
Resistance to internal pressure	table 9	x	x ³⁾

10.5 Inspection of the quality system

Article is deleted, information is already present in chapter 9 and 11, technically there is no change.

12 Titles of standards

12.2 Standards / normative documents

Number ¹⁾	Title
ISO 7-1	Pipe threads where pressure-tight joints are made on the threads - Part 1: Dimensions, tolerances and designation
iso 11922-1	Thermoplastics pipes for the conveyance of fluids – Dimensions and tolerances – Part 1: Metric series (ISO 11922-1:1997)
NEN-EN-ISO 2507-1	Thermoplastics pipes and fittings - Vicat softening temperature - Part 1: General test method
NEN-EN-ISO 2507-2	Thermoplastics pipes and fittings - Vicat softening temperature - Part 2: Test conditions for unplasticized poly(vinyl chloride) (PVC-U) or chlorinated poly(vinyl chloride) (PVC-C) pipes and fittings and for high impact resistance poly (vinyl chloride) (PVC-HI) pipes
nen-en 12118	Plastics piping systems – Determination of moisture content in thermoplastics by coulometry
nen-en 1716	Plastics piping systems – Polyethylene (PE) tapping tees – Test method for impact resistance of an assembled tapping tee
nen-en-iec 60335-1	Household and similar electrical appliances – Safety – Part 1: General requirements
nen-iso 6957	Copper alloys – Ammonia tests for stress corrosion resistance

I Model certificate



CERTIFICATE

Product certificate

<<Kxxxx>>

Issued <<2021-08-21>>

Replaces

Page 1 of 1

<<Product name>>

STATEMENT BY KIWA

With this product certificate, issued in accordance with the Kiwa Regulations for Certification, Kiwa declares that legitimate confidence exists that the products supplied by

<<Certificate holder>>

as specified in this product certificate and marked with the Kiwa®-mark in the manner as indicated in this product certificate may, on delivery, be relied upon to comply with Kiwa evaluation guideline BRL-K17105 "Piping systems of PE for the transport of drinking water and raw water" dated <<[dd-mm-yyyy] inclusive amendment sheet dated dd-mm-yyyy>>.

Ron Scheepers
Kiwa

*This product certificate is valid only in combination with a Kiwa certified plastic piping system.
Advice: consult www.kiwa.nl in order to ensure that this certificate is still valid.*

Kiwa Nederland B.V.
Sir Winston Churchilllaan 273
Postbus 70
2280 AB RIJSWIJK
The Netherlands
Tel. +31 88 968 44 00
Fax +31 88 968 44 20
NL: Kiwa.info@kiwa.com
www.kiwa.nl

Company

<<Certificate holder>>

Tel. +31



Certification process
consists of initial and
regular assessment of:

- quality system
- product

Product certificate

Page 2 of 3

<<Kxxxxx>>

PRODUCT SPECIFICATION

<<Product>> according to evaluation guideline K17105 "Piping systems of PE for the transport of drinking water and raw water".

<<Product description, incl types, dimensions, pressure class, colour, e.a.>>

Fitness for contact with drinking water

This product is approved on the basis of the requirements for hygienic aspects set in the "Regeling materialen en chemicaliën drink- en warm tapwatervoorziening" ("Materials and chemicals in the supply of drinking water and warm tap water Regulation") dated 01-07-2017; published in the Government Gazette).

These hygienic aspects are based on two main criteria. The product shall permanently comply with:



- the product recipe approved during the assessment procedure. This recipe is not to be changed without prior approval by Kiwa according to the Kiwa approval procedure for the hygienic aspects;
- specific product requirements for the hygienic aspects.

The recipe and specific product requirements are laid down in the for confidentiality reasons undisclosed 'appendix hygienic aspects' to this certificate.

MARKING

<<For pipes use>>

Pipes shall be provided with the following marks:

-  or ;
- manufacture's name, trade name;
- material identification: PE 40 or PE 80 or PE 100;
- SDR;
- nominal pressure (PN);
- nominal outside diameter and nominal wall thickness in mm;
- production code
- BRL-K17105 or EN 12201-2

Location of the mark: on each pipe at a distance of up to 2 meters.

The implementation of the marks is as follows: clear, durable and indelible imprint.

<<For fittings use>>

The marks and indications shall be printed or formed on the fitting and the packaging in such a way that it is durable and legible.

Fittings shall be provided with at least the following marks:

- the word "KIWA" and the Kiwa water mark;
- manufacturer's name, trade name and/or logo;
- nominal outside diameter(s) in mm of connecting pipe(s);
- Nominal pressure (PN);
- production code;
- for fittings with a support ring: nominal wall thickness of the connecting pipe;
- Type of fitting body material (only for plastic fittings).

Kiwa water mark:



In consultation with Kiwa:

- the combination of "KIWA" and the Kiwa water mark may be replaced by:
KK or 
- may some marks be printed or formed on the (smallest) packaging unit, e.g. because the fittings are too small to be able to print or form all the marks on the fitting.

APPLICATION AND USE

The products are intended to be used for PE-piping systems for the transport of drinking water and raw water with a maximum temperature of 40°C.

Product certificate

Page 3 of 3

<<Kxxxx>>

RECOMMENDATIONS FOR CUSTOMERS

Check at the time of delivery whether:

- the supplier has delivered in accordance with the agreement;
- the mark and the marking method are correct;
- the products show no visible defects as a result of transport etc.

If you should reject a product on the basis of the above, please contact:

- <<Certificate holder>>

and, if necessary,

- Kiwa Nederland B.V.

Consult the supplier's processing guidelines for the proper storage and transport methods.

Contents

	Preface Kiwa	1
1	Introduction	5
1.1	General	5
1.2	Field of application / scope	5
1.3	Acceptance of test reports provided by the supplier	5
1.4	Quality declaration	5
2	Terminology	6
2.1	Evaluation Guideline (BRL)	6
2.2	Board of Experts	6
2.3	Supplier	6
2.4	IQC scheme	6
2.5	Product requirements	6
2.6	Pre-certification tests	6
2.7	Inspection tests	6
2.8	Product certificate	6
2.9	Tap water	6
2.10	Raw water	6
2.11	Piping system	6
2.12	Design stress of plastic fitting material (σ_{DF})	6
3	Procedure for granting the quality declaration	7
3.1	Pre-certification tests	7
3.2	Granting the quality declaration	7
4	Requirements and test methods for PE piping systems	8
4.1	Requirements to avoid deterioration of the quality of drinking water	8
4.2	Elastomeric sealing elements	8
4.3	Greases and lubricants	8
4.4	PE raw material tested in the form of granules	8
4.4.1	General	8
4.4.2	Colour of the raw material	9
4.4.3	Fusion compatibility for PE 80 and PE 100	9
4.4.4	Classification of the PE material	10
4.4.5	Own reprocessible material	10
4.5	Pressure reduction coefficient for temperatures higher than 20 °C	10
4.6	Installation instructions	10

4.7	Protection of products during storage and transport	10
4.8	Resistance to sunlighth	11
5	Product requirements and test methods: Pipes	12
5.1	PE raw material of the pipe	12
5.2	Pipes with co-extruded layers	12
5.3	Pipes with peelable layer	12
5.4	Weldability of pipes	12
5.5	General characterictis	12
5.5.1	Appearance	12
5.5.2	Colour	12
5.6	Geometrical characteristics	13
5.6.1	Determination of the dimensions	13
5.6.2	Mean outside diameter, out-of-roundness and tolerances	13
5.6.3	Wall thicknesses and tolerances	13
5.7	Physical and mechanical characteristics for PE pipes	14
5.8	Marking	16
6	Product requirements and test methods: Fittings for mechanical joints	17
6.1	Classification	17
6.2	Material	17
6.2.1	General	17
6.2.2	Plastics	17
6.2.3	Metals	18
6.3	General characteristics	18
6.3.1	Appearance	18
6.3.2	Design	18
6.3.3	Colour of plastic fittings	18
6.3.4	Threads	18
6.3.5	Transition fittings to metal pipes	18
6.3.6	Combined fittings	18
6.3.7	Twisting	18
6.4	Geometrical characteristics	18
6.4.1	Determination of the dimensions	18
6.4.2	Dimensions and tolerances	19
6.4.3	Wall thickness of metal fittings	19
6.5	Physical and mechanical requirements plastic fittings	19
6.6	Other requirements of metal fittings	21
6.7	Markings	21
6.7.1	General	21
6.7.2	Certification mark	22
7	Product requirements and test methods: Socket and butt fusion and electrofusion fittings	23
7.1	Weldability	23
7.2	Other requirements	23

7.3	Marking	23
7.3.1	General	23
7.3.2	Certification mark	23
8	Requirements and test methods: Joints	24
8.1	Dimensions	24
8.2	Installation instructions	24
8.3	Fusion joints	24
8.3.1	Welding and Weldability	24
8.3.2	Fusion joints requirements	24
8.4	Mechanical joints	26
8.4.1	Leaktightness test	28
9	Requirements in respect of the quality system	30
9.1	Manager of the quality system	30
9.2	Internal quality control/quality plan	30
9.3	Control of test and measuring equipment	30
9.4	Procedures and working instructions	30
10	Summary of tests and inspections	31
10.1	Test matrix PE piping systems	31
10.2	Test matrix- Pipes	32
10.3	Test matrix - Fittings for mechanical joint	33
10.4	Test matrix - Fusion joints and fittings of PE	34
10.5	Inspection of the quality system	34
11	Agreements on the implementation of certification	35
11.3	Report Pre-certification tests	37
11.9	Interpretation of requirements	38
12	Titles of standards	39
12.1	Public regulation	39
12.2	Standards / normative documents	39
I	Model certificate	42
II	Model IQC scheme	44
III	Guidance for prevention of contamination during transport and storage of new products	45

1 Introduction

1.1 General

This evaluation guideline includes all relevant requirements which are adhered to by Kiwa as the basis for the issue and maintenance of a certificate for plastics piping systems of polyethylene (PE) for the transport of drinking water and raw water.

This evaluation guideline replaces BRL-K17105 dated 2015-03-09.

Certificates issued on the basis of this guideline lose their validity after 2018-10-03.

For the performance of its certification work, Kiwa is bound to the requirements as included in NEN-EN-ISO/IEC 17065 "Conformity assessment - Requirements for bodies certifying products, processes and services".

At setting the requirements the uncertainties of the measurements are taken into account. This implies that drawing conclusions whether requirements are fulfilled these uncertainties do not need to be weighted anymore.

1.2 Field of application / scope

The PE (co extruded) pipes and fittings according to this BRL are intended to be applied in piping systems for the transport of drinking water and raw water with a maximum temperature of 40 °C in accordance with NEN-EN 12201 series.

1.3 Acceptance of test reports provided by the supplier

In case the manufacturer provides reports from test institutions or laboratories showing confirmation that the product meets the requirements of this evaluation guideline, then the institute shall meet the applicable accreditation norms, being;

- NEN-EN-ISO/IEC 17025 for laboratories;
- NEN-EN-ISO/IEC 17020 for inspection bodies;
- NEN-EN-ISO/IEC 17065 for certification bodies certifying products;
- NEN-EN-ISO/IEC 17021-1 for certification bodies certifying systems;
- NEN-EN-ISO/IEC 17024 for certification bodies certifying persons.

This requirement is considered to being fulfilled when a certificate of accreditation can be shown, either issued by the Board of Accreditation (RvA) or one of the institutions with which the RvA has concluded an agreement of mutual acceptance with.

This accreditation should relate to the tests required for this evaluation guideline. If no accreditation certificate can be submitted, the certification body shall verify whether the accreditation standard has been met or carry out the tests concerned.

1.4 Quality declaration

The quality declarations to be issued by Kiwa are described as Kiwa product certificate.

A model of the certificate to be issued on the basis of this evaluation guideline has been included as annex I.

2 Terminology

In this evaluation guideline the terms and definitions, symbols and abbreviations of NEN-EN 12201, parts 1, 2, 3 and 5 and NPR-CEN/TS 12201-7 and following terms and definitions are applicable:

2.1 Evaluation Guideline (BRL)

The agreements made within the Board of Experts on the subject of certification.

2.2 Board of Experts

The Board of Experts "CWK".

2.3 Supplier

The party that is responsible for ensuring that the products meet and continue to meet the requirements on which the certification is based.

2.4 IQC scheme

A description of the quality inspections carried out by the supplier as part of his quality system.

2.5 Product requirements

Requirements made specific by means of measures or figures, focusing on (identifiable) characteristics of products and containing a limiting value to be achieved, which limiting value can be calculated or measured in an unequivocal manner.

2.6 Pre-certification tests

Tests in order to ascertain that all the requirements recorded in the Evaluation Guideline are met.

2.7 Inspection tests

Tests carried out after the certificate has been granted in order to ascertain whether the certified products continue to meet the requirements recorded in the Evaluation Guideline.

2.8 Product certificate

A document, in which Kiwa declares that a product may, on delivery, be deemed to comply with the product specification recorded in the product certificate.

2.9 Tap water

(Origin NEN 1006) water intended for drinking, cooking, food preparation or other domestic purposes.

2.10 Raw water

Water that is used for the production of tap water (drinking water).

2.11 Piping system

The total of pipes, casings, fittings e.g.: bends, valves and other piping components.

2.12 Design stress of plastic fitting material (σ_{DF})

Similar to design stress (σ_s) but for fittings instead of pipe material.

3 Procedure for granting the quality declaration

3.1 Pre-certification tests

The pre-certification tests to be performed are based on the (product) requirements as included in this evaluation guideline including the test methods and contain, depending on the nature of the product to be certified:

- type testing to determine whether the products comply with the product and/or functional requirements;
- assessment of the production process;
- assessment of the quality system and the IQC-scheme;
- assessment on the presence and functioning of the remaining procedure.

3.2 Granting the quality declaration

After finishing the pre-certification tests the results are presented to the person deciding on granting of certificate. This person evaluates the results and decides whether the certificate can be granted or additional data and/or tests are necessary.

4 Requirements and test methods for PE piping systems

This chapter contains the requirements the products have to fulfil, as well as the test methods to determine that the requirements are met.

4.1 Requirements to avoid deterioration of the quality of drinking water

In the Netherlands the following government regulation apply to prevent degradation of the tap water quality.

Products and materials, which (may) come into contact with water, drinking water or warm tap water, are not allowed to release substances in such quantities which can jeopardise the health of the consumer or the quality of the drinking water. For that the products or materials have to meet the toxicological, microbiological and organoleptical requirements which are laid down in the valid "Ministerial Regulation materials and chemicals drinking water- and warm tap water supply" (published in the Government Gazette). This means that the procedure for obtaining a recognised quality declaration, as meant in the valid Regulation, has to be concluded with positive results.

Products and materials with a quality declaration*, issued by e.g. a foreign certification institute, are allowed to be used in the Netherlands, provided that the Minister has declared this quality declaration equivalent to the quality declaration as meant in the Regulation.

4.2 Elastomeric sealing elements

In case rubber sealing elements are present in the joints, the rubber elements shall meet the requirements of Kiwa BRL-K17504.

4.3 Greases and lubricants

Where greases and/or lubricants are used in the making of a joint, these lubricants shall meet the requirements of Kiwa BRL-K535.

4.4 PE raw material tested in the form of granules

4.4.1 *General*

The black PE raw materials used for the manufacturing of the pipes and fittings shall be filled with carbon black.

To the virgin material only anti-oxidants and UV-stabilizers shall be added in those quantities necessary for the manufacture and application of the pipes and fittings.

The added substances shall be equally dispersed within the PE material.

The PE compounds shall conform to the requirements that are summarized in table 1.

The incoming inspection of raw materials shall be recorded in the quality system of the supplier.

* A quality declaration issued by an independent certification institute in another member state of the European Community than the Netherlands or another state party to the agreement to the European Economic Area, is equivalent to a recognised quality declaration, to the extent that, to the judgment of the Minister of the first mentioned quality declaration, is fulfilled the at least equivalent requirements as meant in the Regulation materials and chemicals drinking water- and warm tap water supply.

Table 1 – Requirements PE compound tested in form of granules

Characteristic	Requirement	test parameters		Method
		Parameter	Value	
Density at 23 °C	≥ 930 kg/m ³	Temperature Number of test pieces	23 °C 1	NEN-EN-ISO 1183-1 and NEN-EN-ISO 1183-2
Carbon black content	mass fraction (2 to 2,5) %	Shall conform to ISO 6964		ISO 6964
Dispersion of carbon black	Grade ≤ 3, Rating of dispersion: A1, A2, A3 or B	Shall conform to NEN-ISO 18553		NEN-ISO 18553
Pigment dispersion (blue compound, when applicable)	Grade ≤ 3, Rating of dispersion: A1, A2, A3 or B	Shall conform NEN-ISO 18553		NEN-ISO 18553
Water content	≤ 300 mg/kg ¹⁾	Number of test pieces	1	NEN-EN-ISO 15512
Volatile content (including water)	≤ 350 mg/kg ¹⁾	Number of test pieces	1	NEN-EN 12099
OIT ²⁾	≥ 20	Temperature Number of test pieces Atmosphere Mass test piece	200 °C 3 Oxygen (100%) (15 ± 2) mg	NEN-EN-ISO 11357-6
MFR for PE 40	Between (0,2 to 1,4) g/10 min The measured value of the MFR shall not deviate more than ± 20 % of the specified value.	Load Temperature Time Number of test pieces	2,16 kg 190 °C 10 min. 1	NEN-EN-ISO 1133-1
MFR for PE 80 and PE 100		Load Temperature Time Number of test pieces	5 kg 190 °C 10 min. 1	NEN-EN-ISO 1133-1
1) Sampled directly in front of the extruder. 2) The supplier shall specify the value.				

4.4.2 Colour of the raw material

The colour of the compound shall be blue (PE 80 and PE 100) or black (PE 40, PE 80 and PE 100). The carbon used in the production of black compounds shall have an average (primary) size of 10 nm to 25 nm.

4.4.3 Fusion compatibility for PE 80 and PE 100

The compounds conforming to table 1 are considered fusible to each other.

If this has to be demonstrated experimentally the test according to NEN-EN 12201-1:2011, table 3 shall be performed.

4.4.4 Classification of the PE material

Compounds shall be classified in accordance with NEN-EN 12201-1:2011, clause 4,6 (see table 2).

Table 2 - Classification and designation of the PE types.

Designation	MRS (MPa)	Design stress σ_s ¹⁾ (MPa)	Design coefficient, C
PE40	4	3,2	1,25
PE80	8	6,3	1,25
PE100	10	8,0	1,25

1. The design stress is derived from the MRS by application of the design coefficient C = 1,25.

Note: A higher value for C can be used, e.g. C = 1,6.

4.4.5 Own reprocessable material

The manufacturer may use material prepared from clean rejected unused pipes, fittings or valves, including trimmings from the production of pipes, fittings or valves, that will be reprocessed in a manufacturer's plant after having been previously processed by the same manufacturer in the production of components by e.g. injection-moulding and extrusion.

The manufacturer shall demonstrate that the characteristics of the pipes manufactured from own reprocessable material fulfil the requirements of this evaluation guideline. The manufacturer shall keep records of the reprocessed material in such a way that the products concerned are recognisable for the certification body.

Re-use of material from coextruded pipes is not allowed.

4.5 Pressure reduction coefficient for temperatures higher than 20 °C

When a PE piping system is to be operated at a continuous constant temperature higher than 20 °C, up to 40 °C, a pressure reduction coefficient as given in Table 3 applies.

Table 3 – Pressure reduction coefficients for various temperatures

Material	20 °C	30 °C	40 °C
PE40	0,75	0,56	0,44
PE80	1,00	0,87	0,74
PE100	1,00	0,87	0,74

Note: For other temperatures between each step, interpolation is permitted.

4.6 Installation instructions

The supplier shall provide installation instructions. The instructions shall contain specific information for the assembly of the joints. Also information shall be provided with regard to storage, transport, processing temperature etc. These information shall be provided to the certification body and shall be recorded in the quality system of the supplier.

4.7 Protection of products during storage and transport

For the purpose of hygienic work, products shall be protected against contamination. It concerns the surfaces of the product that in the application come into contact with drinking water. More information is given in annex III.

Precautions to protect the product against contamination shall be agreed upon between the certificate holder (manufacturer) and the client and shall be recorded in the quality management system.

4.8 Resistance to sunlighth

The resistance to weathering of the material of the products shall comply to the requirements listed in NEN-EN 12201-1:2011 Table 2, fourth row.

5 Product requirements and test methods: Pipes

This chapter lists the product requirements the pipe must meet and the test methods.

5.1 PE raw material of the pipe

The PE raw material of the pipe shall comply to the requirements in this evaluation guideline, clause 4.1 and clause 4.4.

5.2 Pipes with co-extruded layers

Pipes with co-extruded layers shall comply with NEN-EN 12201-2:2011 + A1: 2013 Annex B, with the exception that own reprocessible material may be used.

The pipes shall be provided with co-extruded green coloured stripes made from the same base material for which the fusibility between the raw materials is proven.

5.3 Pipes with peelable layer

Pipes with a peelable layer shall comply with NEN-EN 12201-2:2011 + A1: 2013 Annex C.

The pipes shall be provided with co-extruded green coloured stripes made from the same base material for which the fusibility between the raw materials is proven.

5.4 Weldability of pipes

The PE 80 and PE 100 pipes shall possess good weld ability: during destructive testing no brittle fracture at the welding zone shall occur.

By means of test welds, the manufacturer shall demonstrate that the requirements for weld ability of the pipes according NEN 7200 are fulfilled.

In case the welding test parameters are not mentioned in NEN 7200, the producer or supplier of the pipes shall provide these to the certification body and interested end users.

5.5 General characteristics

5.5.1 Appearance

The inside and outside surface of the pipes shall be smooth, sound and clean, free of bubbles, holes, cracks or other irregularities. No contaminations in the material are allowed. The ends of the pipes shall be smooth and square.

5.5.2 Colour

5.5.2.1 General

For the transport of drinking water in accordance with the scope of this evaluation guideline, only black coloured pipes with blue stripes and pipes with a co-extruded blue coloured outer layer shall be used, with exception of PE 100 for which also uniform blue coloured pipes are allowed.

For uniform blue coloured pipes the requirement for resistance to weathering according to NEN-EN 12201-1, table 2, fourth row applies.

5.5.2.2 Dimensions of the blue stripes

Black pipes shall be provided with co-extruded blue coloured stripes made from the same base material for which the fusibility between the raw materials is proven.

The stripes shall be equally distributed along the circumference of the pipe. The dimensions shall comply with the specifications as given in table 4.

Table 4 - Dimensions of co-extruded strips (in mm)

Pipe diameter d_n	Minimum number of stripes	minimal width of strips	Maximal depth of strips
< 32	3	1	$0,2 \times e_n$
$32 \leq d_n \leq 63$	3	2	$0,2 \times e_n$
$75 \leq d_n \leq 160$	4	4	$0,15 \times e_n$
$180 \leq d_n \leq 400$	4	9	$0,15 \times e_n$
$d_n \geq 450$	6	12	$0,1 \times e_n$

5.6 Geometrical characteristics

5.6.1 Determination of the dimensions

The dimensions of the pipe shall be measured in accordance with NEN-EN-ISO 3126 and rounded to the next 0,1. In the case of dispute the measurements of dimensions shall be made not less than 24 hours after manufacture after being conditioned for at least 4 hours at a temperature of $(23 \pm 2) ^\circ\text{C}$.

5.6.2 Mean outside diameter, out-of-roundness and tolerances

5.6.2.1 Straight pipes

The mean outside diameters, d_{em} , and the out-of-roundness shall be in accordance with NEN-EN-12201-2:2011 + A:2013, table 1.

5.6.2.2 Coiled pipes

For coiled pipes made of PE 40, the maximum out-of-roundness shall be measured directly after extrusion and shall comply to table 5.

For coiled pipes made of PE 40 and with a nominal diameter, d_n , < 110 mm, the core diameter of the reel shall be at least $24 \times d_n$.

For coiled pipes made of PE 40 and with a nominal diameter, d_n , ≥ 110 mm, the core diameter of the reel shall be at least $18 \times d_n$.

For coiled pipes made of PE 80 and PE 100, the maximum out-of-roundness shall be specified by agreement between the manufacturer and the end-user.

5.6.3 Wall thicknesses and tolerances

The wall thickness of pipes made of PE 40 shall be in accordance with table 5.

The wall thickness of pipes made of PE 80 or PE 100 shall be in accordance with NEN-EN 12201-2:2011+A1:2013, table 2.

Note: The relationship between PN, MRS, S, SDR is given in NEN-EN 12201-2:2011+A1:2013, table A.1.

Table 5 - Outside diameter, out-of-roundness and wall thickness of PE 40 pipes (in mm)

					pipe series			
					SDR 9 S 4		SDR 6 S 2,5	
					Nominal pressure PN in bar			
					6		10	
			Out-of-roundness		Wall thickness			
d_n	$d_{em,min}$	$d_{em,max}$	straight pipe	coiled pipe	min	max	min	max
16	16,0	16,3	0,7	2,0	1,8	2,2	2,7	3,2
20	20,0	20,3	0,8	2,4	2,2	2,7	3,4	4,0
25	25,0	25,3	1,0	3,0	2,7	3,2	4,2	4,9
32	32,0	32,3	1,3	3,9	3,5	4,1	5,4	6,2
40	40,0	40,4	1,6	4,8	4,3	5,0	6,7	7,6
50	50,0	50,4	2,0	6,0	5,4	6,2	8,3	9,4
63	63,0	63,4	2,6	7,6	6,8	7,7	10,5	11,8

Note: PN values are based on C = 1,6

5.7 Physical and mechanical characteristics for PE pipes

The requirements are summarized in table 6.



Table 6 - Physical and mechanical requirements of PE pipes.

Characteristic	Requirement	Test parameters		Method
		Parameter	Value	
MFR, PE40	After processing maximum deviation of $\pm 20\%$ of the value measured on the batch used to manufacture the pipe.	Mass Temperature Time Number of test pieces	2,16 kg 190 °C 10 minutes According to NEN-EN-ISO 1133-1	NEN-EN-ISO 1133-1
MFR, PE80 and PE100	After processing maximum deviation of $\pm 20\%$ of the value measured on the batch used to manufacture the pipe.	Mass Temperature Time Number of test pieces	5,0 kg 190 °C 10 minutes According to NEN-EN-ISO 1133-1	NEN-EN-ISO 1133-1
OIT	≥ 20 min.	Temperature Number of test pieces Atmosphere Mass test piece	200 °C 3 Oxygen (100%) (15 \pm 2) mg	NEN-EN-ISO 11357-6
Elongation at break for $e_n \leq 5$ mm	$\geq 350\%$ for all pipes. For pipes with stripes delamination between the material of the stripe and the pipe is not allowed.	Test piece shape Speed of testing Number of test pieces	Type 2 see part 3 of test method see part 1 of test method	NEN-EN-ISO 6259-1 en NEN-EN-ISO 6259-3:1997.

Elongation at break for $5 \text{ mm} \leq e_n \leq 12 \text{ mm}$	$\geq 350 \%$ for all pipes. For pipes with stripes delamination between the material of the stripe and the pipe is not allowed.	Test piece shape Speed of testing Number of test pieces	Type 1 see part 3 of test method. see part 1 of test method	NEN-EN-ISO 6259-1 en NEN-EN-ISO 6259-3:1997.			
Elongation at break $e_n > 12 \text{ min}$	$\geq 350 \%$ for all pipes. For pipes with stripes delamination between the material of the stripe and the pipe is not allowed.	Test piece shape Speed of testing Number of test pieces	Type 1 see part 3 of test method. see part 1 of test method	NEN-EN-ISO 6259-1 en NEN-EN-ISO 6259-3:1997.			
		or: Test piece shape Speed of testing Number of test pieces	Type 3 see part 3 of test method see part 1 of test method				
Longitudinal reversion	$\leq 3 \%$ Original appearance of the pipe shall remain	Temperature: PE 40 PE 80 PE 100 Length test piece Time Number of test pieces	100 °C 110 °C 110 °C 200 mm see NEN-EN 2505 3	NEN-EN-ISO 2505			
Resistance to internal pressure ²⁾	No failure during test period of any test piece.	End cap ¹⁾ Number of test pieces Test type	Type A 3 ³⁾ Water-in-water	NEN-EN-ISO 1167-1 en NEN-EN-ISO 1167-2			
		Time (hours)	T (°C)		Circumferential stress in pipe wall (MPa)		
					PE40	PE80	PE100
		> 1	20		8,0	-	-
		> 100	20		7,0	10,0	12,0
		> 165	80		2,5	4,5	5,4
> 1000	80	2,0	4,0	5,0			
<p>1) Type A or type B end caps shall be used for $d_n \geq 500 \text{ mm}$.</p> <p>2) For pre-certification and inspections a test duration of 1000 hours at a temperature of 80 °C shall be used. The other test parameter may be used in process verification tests (PVT).</p> <p>3) The number of test pieces given is required for Type Testing. The number of test pieces required for factory production control and process control shall be listed in the quality plan of the supplier.</p>							

5.8 Marking

Pipes shall be provided with the following marks:

- **KIWA**  or **KIWA** ;
- manufacture's name, trade name;
- material identification: PE 40 or PE 80 or PE 100;
- SDR;
- nominal pressure (PN);
- nominal outside diameter and nominal wall thickness in mm;
- production code
- BRL-K17105 or EN 12201-2

Location of the mark: on each pipe at a distance of up to 2 meters.

The implementation of the marks is as follows: clear, durable and indelible imprint.

6 Product requirements and test methods: Fittings for mechanical joints

This chapter embodies the product requirements and test methods mechanical fittings have to comply to.

Fusion fittings are described in chapter 7.

The connection requirements for the fittings are described in chapter 8.

The requirements and test methods for fittings for mechanical joint are based on NEN-ISO 17885.

6.1 Classification

Mechanical fittings shall be classified as follows:

- According to the connecting system, as follows:
 - type 1: external-grip fitting (compression type fitting), which grip the pipe only at its outer surface;
 - type 2: internal/external-grip fittings, which grip or support the pipe both at the inner and outer surface of the pipe;
- According to the resistance of the fitting to the longitudinal forces which develop as a result of the internal pressure, as follows:
 - class 1: end-load-bearing compression fittings,
 - class 2: non-end-load-bearing compression fittings.

6.2 Material

6.2.1 General

The material of the fitting components which are in contact with drinking water shall conform to clause 4.1.

The material and constituents elements used in making the fitting (including elastomers, greases, and any metal parts) shall be as resistant to the external and internal environments as the other elements of the piping system and shall have a life expectancy at least equal to that of the PE pipe conforming to EN 12201-2.

The incoming inspection of raw materials shall be recorded in the quality system of the supplier.

6.2.2 Plastics

Raw material(s) e.g. PP-H, PP-R, PP-B, POM homopolymer, POM copolymer of the fitting body shall comply to the requirements specified in table 7.

Note: For example (e.g.) is used here to prevent exclusion of innovative products.

Suppliers of innovative products shall demonstrate that the products fulfil the requirements of BRL-K17105.

Table 7 - MRS value and design stress of various fitting materials

	POM		PP			PE	
	Homo-polymer	Co-polymer	PP-H	PP-B	PP-R	PE 80	PE 100
MRS (MPa)	10	10	10	8	8	8	10
Design coefficient, C	1,6	1,6	1,6	1,25	1,25	1,25	1,25
Design stress, σ_{DF} (MPa)	6,3	6,3	6,3	6,3	6,3	6,3	8

The producer of the fittings must specify to Kiwa of what materials the fittings are made.

The material for the production of PE fittings shall meet the requirements specified in NEN-EN-ISO 12201-3:2011+A1:2012, clause 4.1.

6.2.3 Metals

Fittings shall be made from materials listed in NEN-ISO 17885:2015: table 2 or table 3.

6.3 General characteristics

6.3.1 Appearance

The internal and external surfaces of fittings made of plastics shall be clean and free from grooves, pinholes, voids and other features likely to cause the fitting to fail to conform to any requirements of this evaluation guideline.

Castings shall in all respects be sound and free from laps, blowholes and pitting, and both the external and the internal surfaces shall be clean, smooth and free from sand.

6.3.2 Design

The design of the fitting shall be such that, when assembling the fitting onto the pipe or other component, the seals are not displaced or damaged. The technical drawing of the design of joints shall be part of the quality system of the supplier.

6.3.3 Colour of plastic fittings

The colour of the fitting shall be black or blue. For fabricated fittings the colour characteristics of the pipes apply.

6.3.4 Threads

Pipe threads where pressure-tight joints are made on the threads shall conform to ISO 7-1 or ISO 228-1.

6.3.5 Transition fittings to metal pipes

Where a fitting is connected to a metal pipe the joint shall fulfil at least the performance requirements of the plastic piping system. The fitting part connected to the metal pipe shall fulfil the dimensional requirements of the corresponding metal pipe and its product standard.

6.3.6 Combined fittings

Socket fusion ends, spigot ends, electrofusion sockets or others, when included in mechanical fittings, shall conform to the relevant product standards.

6.3.7 Twisting

The fitting shall not induce twisting of the pipes during assembly.

6.4 Geometrical characteristics

6.4.1 Determination of the dimensions

The dimensions of the fitting shall be measured in accordance with NEN-EN-ISO 3126 and rounded to the next 0,1. In the case of dispute the measurements of dimensions shall be made not less than 24 hours after manufacture after being conditioned for at least 4 hours at a temperature of (23 ± 2) °C.

6.4.2 Dimensions and tolerances

The dimensions of the fittings shall be suitable for the pipes as specified in chapter 5 of this evaluation guideline. For dimensions not specified, the values and tolerances according to the technical drawings of the manufacturer apply. The technical drawing shall be part of the quality system of the supplier.

Stiffeners (pipe inserts) are recommended for thin wall pipes. If stiffeners are used, they shall comply to NEN-ISO 17885:2015, annex B.

In order to avoid excessive pressure loss, internal support - e.g. stiffeners - should cause minimal narrowing of internal cross-section of the fitting. The minimal internal bore diameter of the fitting shall be stated by the manufacturer in his technical file.

6.4.3 Wall thickness of metal fittings

The wall thickness of the metal fittings, in any cross-section, shall not be smaller than indicated in table 8.

Table 8 - Minimum permissible wall thickness of metal fittings of bronze or messing (in mm).

Outside diameter of the connecting pipe	Cast work	Warm press work
12	1,4	1,4
16	1,4	1,4
20	1,6	1,4
25	1,8	1,5
32	1,0	0,6
40	2,2	0,8
50	2,3	2,0
63	2,8	2,3

6.5 Physical and mechanical requirements plastic fittings

The plastic fittings shall also meet the requirements listed in Table 9.

Table 9 - Physical and mechanical requirements of plastic fittings

Characteristic	Requirement	Test parameters		Method
		Parameter	Value	
MRS value	Design stress, σ_{DF} , according to relevant product standard.	Conventional procedure e.g. for PE according to NEN-EN 12201-1:2011, clause 4.6.		NEN-EN-ISO 1167 series in combination with NEN-EN-ISO 9080
Effect of heating	The maximum dimensions of cracks, delamination, blisters weld-line openings, damage around the sprue point shall be < 30 % relative to the wall thickness of the product.	Test parameters (temperature and duration of heating) in accordance with the relevant product standard and as recorded in the IQC scheme. For PP (150 ± 2) °C and at least 60 minutes. For POM (160 ± 2) °C and at least 60 minutes.		NEN-EN-ISO 580
		End caps	A	

Resistance to internal pressure	No failure during test period of any test piece	Number of test pieces		3		NEN-EN-ISO 1167 series		
		Test type		Water-in-water				
		POM						
		Homopolymer fittings			Copolymer fittings			
		T (°C)	t (h)	p_T (bar)	T (°C)		t (h)	p_T (bar)
		20	1	6,3xPN	20		100	5,0 x PN
		60	1000	1,5xPN	60		1000	0,9 x PN
					95		400	0,95 x PN
		PP fittings						
		Type	T (°C)	t (h)	p_T (bar)			
		PP-H	20	1	3,3 x PN			
			60	1000	0,9 x PN			
			95	1000	0,55 x PN			
		PP-B	20	1	2,5 x PN			
			80	3000	0,75 x PN			
			95	1000	0,4 x PN			
		PP-R	20	1	2,5 x PN			
80	3000		0,7 x PN					
95	1000		0,55 x PN					
PE fittings								
Type	T (°)	t (h)	σ (MPa) ¹⁾					
PE80	20	100	10,0					
	80	165	4,5					
	80	1000	4,0					
PE100	20	100	12,0					
	80	165	5,4					
	80	1000	5,0					
MFR for PE fittings of: PE40; PE80; PE100	After processing maximum deviation of ± 20 % of the value measured on the batch used to manufacture the fitting.	See this BRL, table 1.						
MRF for fittings of PP	After processing maximum deviation of ± 20 % of the value measured on the batch used to manufacture the fitting.	See relevant product standard and as recorded in the IQC scheme						
MFR for fittings of POM		See relevant product standard and as recorded in the IQC scheme						
OIT for PE	≥ 20 minutes	Temperature Number of test pieces Atmosphere mass test piece	200 °C 3 Oxygen (100 %) (15 ± 2) mg	NEN-EN-ISO 11357-6				
OIT for PP	≥ 20 minutes	Temperature Number of test pieces Atmosphere mass test piece	200 °C 3 Oxygen (100 %) (15 ± 2) mg	NEN-EN-ISO 11357-6				
1) Minimum circumferential stress in the wall of the connecting pipe. Pipe and fitting shall have the same PN class.								

6.6 Other requirements of metal fittings

The metal fittings shall also meet the requirements listed in Table 10.

Table 10 - Additional requirements of metal fittings

Characteristics	Requirement	Test parameters		Method
		Parameter	Value	
Fittings with compression ends 1)	conform NEN-EN 1254-3	As recorded in the IQC scheme		conform NEN-EN 1254-3
Dimensions and design	Conform NEN-EN 1254-3 for the body and conform ISO 7-1 en ISO 228-1 for the screw thread	Technical drawings		Conform NEN-EN 1254-3 for the body and conform ISO 7-1 en ISO 228-1 for the screw thread
Strength of the body	No visual indication of leakage	NEN-EN 1254-3:1998, clause 5.1		
Resistance to stress corrosion	The fitting shall be resistant to stress corrosion. Components manufactured from copper alloys shall show no evidence of cracking.	NEN-EN 1254-3:1998, clause 5.10.		
1) Components other than bodies will possibly be made of suitable non-metallic materials. These materials should not cause degradation of the connected plastics pipe and shall comply to clause 4.1.				

6.7 Markings

6.7.1 General

The marks and indications shall be printed or formed on the fitting and the packaging in such a way that it is durable and legible.

Fittings shall be provided with at least the following marks:

- manufacturer's name, trade name and/or logo;
- nominal outside diameter(s) in mm of connecting pipe(s);
- Nominal pressure (PN);
- production code;
- for fittings with a support ring: nominal wall thickness of the connecting pipe;
- Type of fitting body material (only for plastic fittings).

6.7.2 **Certification mark**

After entering into the Kiwa certification agreement the word “KIWA” and the Kiwa water mark must be printed or formed on the fitting.

Kiwa water mark:

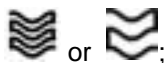

In consultation with Kiwa:

- the combination of “KIWA” and the Kiwa water mark may be replaced by;

KK of KK

- may some marks be printed or formed on the (smallest) packaging unit, e.g. because the fittings are too small to be able to print or form all the marks on the fitting.

7 Product requirements and test methods: Socket and butt fusion and electrofusion fittings

Product requirements and test methods apply on injection moulded butt fusion and socket fusion fittings and injection moulded electrofusion fittings made from PE 80 and PE 100 for transport of drinking water.

7.1 Weldability

The fittings shall be adequately weld able in combination with pipes and among themselves.

7.2 Other requirements

The spigot end fittings, socket fusion fittings and electrofusion fitting shall conform to NEN-EN 12201-3.

7.3 Marking

7.3.1 General

The marks and indications shall be printed or formed on the fitting and the packaging in such a way that it is durable and legible.

Fittings shall be provided with at least the following marks:

- manufacturer's name, trade name and/or logo;
- nominal outside diameter(s) in mm of connecting pipe(s);
- Nominal pressure (PN);
- production code;
- material identification of the plastic PE 40 or PE 80 or PE 100

7.3.2 Certification mark

After entering into the Kiwa certification agreement the word "KIWA" and the Kiwa water mark must be printed or formed on the fitting.

Kiwa water mark:

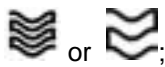

In consultation with Kiwa:

- the combination of "KIWA" and the Kiwa water mark may be replaced by;

KK of 

- may some marks be printed or formed on the (smallest) packaging unit, e.g. because the fittings are too small to be able to print or form all the marks on the fitting.

8 Requirements and test methods: Joints

In this chapter the product requirements and test methods for joints between fittings and pipes are listed.

8.1 Dimensions

In case the joints require a smaller tolerance for the mean outside diameter and/or out-of-roundness, this shall be agreed upon between the manufacturer and the end-user and shall be specified to the certification body.

8.2 Installation instructions

See clause 4.6.

8.3 Fusion joints

8.3.1 *Welding and Weldability*

The fittings shall be adequately weld able in combination with pipes and among themselves.

The pipe manufacturer shall declare which pipes from his own product range conforming to NEN-EN 12201-2 are compatible to each other for butt fusion.

The fitting manufacturer shall declare the SDR range and MRS values of pipes conforming to EN 12201-2 to which his fittings conforming to EN 12201-3 can be fused by using the same procedures (e.g. times, temperatures, fusion pressures) to conform to this standard. If there is a need for deviation in fusion procedures the fitting manufacturer shall state this clearly. If there is such a statement it shall be recorded in the quality plan of the supplier.

In the case of butt fusion joints, the welding instructions and parameters in accordance with NEN 7200 shall be applied. In case the materials complying with this evaluation guideline require different welding parameters as specified in NEN 7200, these deviating parameters shall be included in an instruction paper (in the Dutch language) and supplied to the certification body and end-users. In that case, test samples shall be welded with these different welding parameters.

Note: Beside NEN 7200, NEN-ISO 21307 should be used for guidance for the butt fusion jointing procedure.

In the case of electrofusion joints, the recommendations according to NIL publication vm102 shall be followed, unless otherwise specified by the manufacturer of the electrofusion fittings.

Socket fusion joints shall be produced according to the instructions of the manufacturer of the socket fusion fittings. These instructions shall be recorded in the quality plan of the supplier.

8.3.2 *Fusion joints requirements*

The joints shall be made using pipes and fittings conforming to this evaluation guideline.

The butt fusion PE pipe joints, socket fused joints and electrofusion joints shall be prepared in accordance with the manufacturer's instructions or the instructions

specified in the relevant standards (e.g. NEN 7200, NEN-ISO 21307, NEN-ISO 11414, NEN-ISO 11413).

Butt fusion, socket fusion and electrofusion joints are applicable for components in PE 100 and PE 80 materials. Pipes in PE 40 material are joined using mechanical fittings only.

The peelable layer of peelable layer pipe shall be removed in the area of the joint prior to making of the joint.

Fusion joints shall comply to the requirements specified in table 11.

Table 11 - Leaktightness and strength of fusion joints

Characteristic	Requirement	Test parameters		Method
		Parameter	Value	
Butt fusion (pipe to pipe) or spigot end (pipe to fitting) joints				
Failure mode of butt-fused joint	Test specimens shall show no brittle fracture behaviour	Temperature Number of test pieces	(23 ± 2) °C see method	NEN 7200 or alternatively ISO 13953
Resistance to internal pressure ¹⁾	No failure and leakages during test	End cap Number of test pieces Test type Temperature Time Circumferential stress ³⁾ : PE40 PE80 PE100	Type A ²⁾ 3 Water-in-water 80 °C 1000 hours 2,0 MPa 4,0 MPa 5,0 MPa	NEN-EN-ISO 1167-1 and NEN-EN-ISO 1167-2
Socket fusion joints				
Resistance to internal pressure ¹⁾	No failure and leakages during test	End cap Number of test pieces Test type Temperature Time Circumferential stress ³⁾ : PE40 PE80 PE100	Type A ²⁾ 3 Water-in-water 80 °C 1000 hours 2,0 MPa 4,0 MPa 5,0 MPa	NEN-EN-ISO 1167-1 and NEN-EN-ISO 1167-2
Electrofusion joints				
Resistance to internal pressure ¹⁾	No failure and leakages during test	End cap Number of test pieces Test type Temperature Time Circumferential stress ³⁾ : PE40 PE80 PE100	Type A ¹⁾ 3 Water-in-water 80 °C 1000 hours 2,0 MPa 4,0 MPa 5,0 MPa	NEN-EN-ISO 1167-1 and NEN-EN-ISO 1167-2
Peel decohesion resistance test for PE electrofusion assemblies with d _n ≥ 90 mm	Length of initiation rupture ≤ L ₂ /3 in brittle failure	Temperature Number of test pieces	(23 ± 2) °C 3	ISO 13954
Crushing decohesion test for PE	C _c ≤ 30 %	Temperature Number of test pieces	(23 ± 2) °C 3	ISO 13955 ⁴⁾

electrofusion assemblies				
Saddle fusion joints ⁵⁾				
Resistance to internal pressure ¹⁾	No failure and leakages during test	End cap Number of test pieces Test type Temperature Time Circumferential stress ³⁾ : PE 40 PE 80 PE 100	Type A ²⁾ 3 Water-in-water 80 °C 1000 hours 2,0 MPa 4,0 MPa 5,0 MPa	NEN-EN-ISO 1167-1 and NEN-EN-ISO 1167-2
Decohesion test for saddle fusion assemblies	$L_d \leq 50\%$ and $A_d \geq 25\%$,	Temperature Number of test pieces	$(23 \pm 2) ^\circ\text{C}$ 3	NEN-ISO 13956
Crushing decohesion test for PE electrofusion	$C_c \leq 30\%$	Temperature Number of test pieces	$(23 \pm 2) ^\circ\text{C}$ 3	ISO 13955 ⁴⁾
<p>1) Batch release tests and process verification tests may be carried out at different temperatures and times and, if applicable shall be recorded in the IQC scheme of the supplier.</p> <p>2) Type B end caps may be used for testing pipes with nominal diameters greater than 500 mm.</p> <p>3) Minimum circumferential stress in the wall of the connecting pipe.</p> <p>4) Test method can be used for $16 \leq d_n \leq 225$ mm pipe assemblies.</p> <p>5) Both test methods are allowed for $d_n \leq 225$ mm assemblies, for $d_n > 225$ mm ISO 13956 shall be used.</p>				

8.4 Mechanical joints

The joints shall be made using pipes and fittings conforming to this evaluation guideline.

Test pieces for pressure tests shall be closed with pressure-tight, end-load-bearing end caps, plugs or flanges which shall be provided with connections for entry of water and release of air into the test piece.

The mechanical joints shall comply to the requirements specified in table 12 and table 13.

Table 12 - Leaktightness and strength of mechanical joints

Characteristic	Requirement	Test parameters		Method
		Parameter	Value	
Leaktightness under internal pressure of assemblies subjected to bending for $d_n \leq 63$ mm	No leakage nor failure of the joint during the test	Temperature Duration Pressure Number of test pieces	(23 ± 2) °C > 60 min. 1,5 x PN 3	NEN-EN-ISO 3503 ¹⁾
Leaktightness under internal pressure of assemblies subjected to bending for $d_n \geq 75$ mm	No leakage nor failure of the joint during the test	Temperature Duration Pressure Number of test pieces	(23 ± 2) °C > 60 min. 1,5 x PN 3	This BRL Clause 8.4.1
Leaktightness under external hydrostatic pressure for $d_n \leq 63$ mm	No leakage nor failure of the joint during the test	Method Temperature Pressure (p_1) ²⁾ Duration Pressure (p_2) ²⁾ Duration Number of test pieces	B (23 ± 2) °C - 0,01 MPa > 60 min. - 0,08 MPa > 60 min. 1	NEN-EN-ISO 3459
Resistance to pull-out under constant longitudinal force	No pull-out or separation of the pipe from the fitting	Temperature Duration Test stress Number of test pieces	(23 ± 2) °C > 60 min. PE40: 3,3 MPa PE80: 5,7 MPa PE100: 6,6 MPa 3	NEN-EN-ISO 3501
Leaktightness under internal water pressure	No failure of any of the test pieces and leaks during the test period	Test parameters	See table 13	NEN-EN-ISO 1167-1, NEN-EN-ISO 1167-4
1) See annex A of NEN-EN-ISO 3503:2015 for other test parameters. 2) Pressure difference over the wall of the pipe assuming 1 bar atmospheric pressure.				

Table 13 – Test parameters for the determination of the leaktightness and strength of joints

Type pipe material	Test temperature (°C)	Circumferential stress in pipe wall (MPa)	Test duration (hours)
PE40 ¹⁾	20	7,0	100
	40	-	1000
	60	-	1000
	80	2,0	1000
PE80 ¹⁾	20	10,0	100
	40	6,8	1000
	60	5,2	1000
	80	4,0	1000
PE100 ¹⁾	20	12,0	100
	40	8,4	1000
	60	6,4	1000
	80	5,0	1000

- 1) Values for the minimum required hydrostatic strength (reference lines) are derived from NEN-EN 12201-2.
- 2) The test may be carried out at 40 °C and 60 °C when problems with the leaktightness occur at a test temperature of 80 °C.
- 3) The pipes shall fulfil the requirements listed in chapter 5 and shall have the same pressure class PN as the fitting tested.
- 4) Water-in-water test according to NEN-EN-ISO 1167-1.
- 5) Type end capes during the test depends on classification of the fitting (see clause 6.1).
- 6) Tolerance of the test temperature is ± 0,5 °C.
- 7) Length of the assembly shall be 10 x d_n but no less than 500 mm.
- 8) The test pressure is calculated with the following equation:

$$p = \frac{2 \times \sigma \times e_{min}}{d_n - e_{min}}$$

where:

p = the internal hydrostatic pressure during the test;

σ = the required wall stress in the pipe pieces;

e_{min} = de minimum wall thickness of the pipe pieces.

- 9) The calculation of the internal hydrostatic pressure shall be based on e_{min} and d_n of the polyethylene pipe with a pressure class which corresponds to the pressure class of the fitting.
- 10) De test parameters for Audits (AT), batch releases (BRT) and for process verification (PVT) shall be recorded in the quality system of the supplier.

8.4.1 Leaktightness test

This test also applies for fittings smaller than Ø 75 mm in case a test according to NEN-EN-ISO 3503 cannot be carried out due to the design of the fitting.

Test set-up

For the test a test set-up is required according to figure 2, including a installation unit with control equipment for applying and maintaining hydraulic pressure.

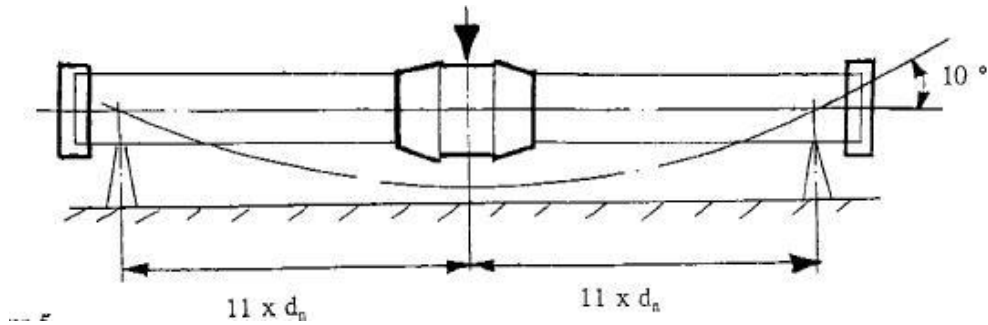

Figure 2 - Test set-up.

8.4.1.1 Test pieces

The test pieces shall be assembled in accordance with the instructions of the manufacturer. The length of the piece of pipe between the fitting and the end cap shall be $11 \times d$ with a minimum of 500 mm. Use shall be made of PE pipes complying with the requirements of chapter 5 of this evaluation guideline.

8.4.1.2 Test parameters

The test shall be carried out at a temperature of 23 ± 2 °C. Fill the test piece with water till a pressure of $0,5 \times PN$. Load the test piece in the middle of the fitting till the in figure 3 illustrated angle of 10° is reached.

Fixate the test piece in this position and carry out the test with internal hydrostatic pressure scheme according to figure 3. Inspect during testing the tightness of the fittings, as well as the tightness of the connections between the fittings and the pipes. After testing the pipe pieces are taken apart after which the pipe ends and fittings (on both sides) are inspected with regard to damages and breakage.

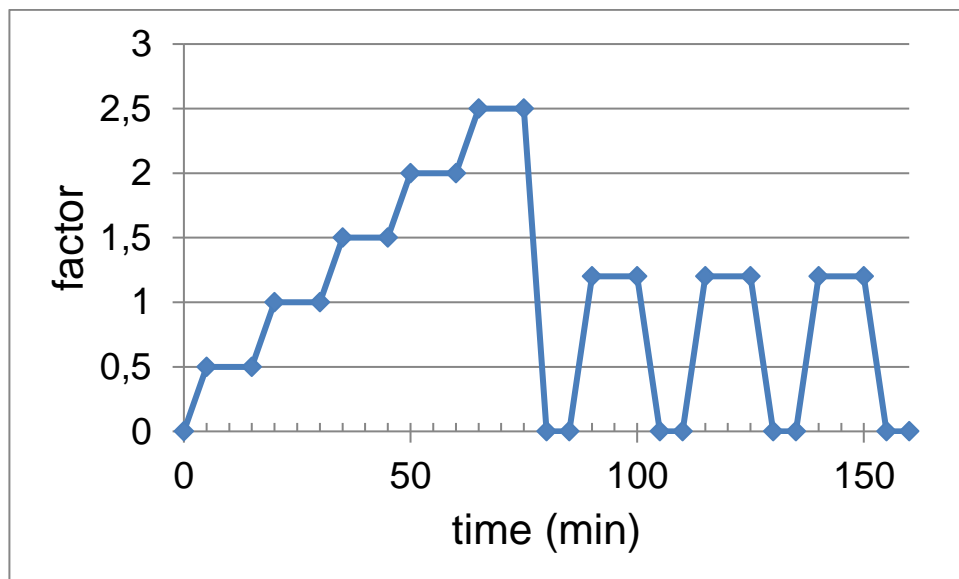

Figure 3 - Pressure time diagram.

9 Requirements in respect of the quality system

This chapter contains the requirements which have to be met by the supplier's quality system.

9.1 Manager of the quality system

Within the supplier's organizational structure an employee must have been appointed who is in charge of managing the supplier's quality system.

9.2 Internal quality control/quality plan

The supplier shall have an internal quality control scheme (IQC scheme) which is applied by him.

The following must have been demonstrably recorded in this IQC scheme:

- what aspects are checked by the producer;
- according to what methods such inspections are carried out;
- how often these inspections are carried out;
- in what way the inspection results are recorded and kept.

This IQC scheme should at least be an equivalent derivative of the model IQC scheme included in annex II

9.3 Control of test and measuring equipment

The supplier shall verify the availability of necessary test and measuring equipment for demonstrating product conformity with the requirements in this evaluation guideline. When required the equipment shall be kept calibrated (e.g. recalibration at interval). The status of actual calibration of each equipment shall be demonstrated by traceability through an unique ID.

The supplier must keep records of the calibration results.

The supplier shall review the validity of measuring data when it is established at calibration that the equipment is not suitable anymore.

9.4 Procedures and working instructions

The supplier shall be able to submit the following:

- procedures for:
 - dealing with products showing deviations;
 - corrective actions to be taken if non-conformities are found;
 - dealing with complaints about products and/or services delivered;
- the working instructions and inspection forms used.

10 Summary of tests and inspections

This chapter contains a summary of the following tests and inspections to be carried out in the event of certification:

- Pre-certification tests;
- Control after certification;
- Control of the supplier's the quality system.

10.1 Test matrix PE piping systems

Table 14 – Test matrix PE piping systems

Description of requirements	Clause BRL	Tests within the scope of:	
		Pre-certification	Control after issue of the certificate ^{1), 2)}
General			
Deterioration in the quality of drinking water	4.1	x	x ³⁾
Elastomeric sealing elements	4.2	x	x ³⁾
Greases and lubricants	4.3	x	x
Installation instructions	4.6	x	x
Protection products during storage and transport	4.7	x	x
PE raw material tested in the form of granulate			
Density	table 1	x	x
Carbon black content	table 1	x	x
Carbon black dispersion	table 1	x	x
Pigment dispersion	table 1	x	x
Water content	table 1	x	x
Volatile content	table 1	x	x
OIT	table 1	x	x
MFR	table 1	x	x ³⁾
Colour	4.4.2	x	x
Fusion compatibility for PE 80 and PE 100	4.4.3	x	x
Classification of the PE material	4.4.4	x	x
Own reprocessed material	4.4.5	x	x

1. In case the product or production process changes significantly, the performance requirements shall be determined again.
2. During the inspection visit, the inspector shall check the product on the basis of a selection of the above listed requirements. The frequency of the inspection visits is recorded in clause 11,6 "Nature and frequency of external inspections".
3. When applicable, once a year the inspector samples for an Audit Test.

10.2 Test matrix- Pipes

Table 15 – Test matrix - Pipes

Description of requirements	Clause BRL	Tests within the scope of:	
		Pre-certification	Control after issue of the certificate ^{1), 2)}
PE raw material of the pipe	5.1	x	x
Resistance to sunlight	5.2	x	-
Pipes with co-extruded layers	5.3	x	-
Weld ability pipes	5.4	x	x
Appearance	5.5.1	x	x
Colour	5.5.2	x	x
Geometric characteristics	5.5.6	x	x
MFR	table 6	x	x ³⁾
OIT	table 6	x	x ³⁾
Elongation at break	table 6	x	x
Longitudinal reversion	table 6	x	x
Resistance to internal pressure	table 6	x	x ³⁾
Markings	5.8	x	x

1. In case the product or production process changes significantly, the performance requirements shall be determined again.
2. During the inspection visit, the inspector shall check the product on the basis of a selection of the above listed requirements. The frequency of the inspection visits is recorded in clause 11,6 "Nature and frequency of external inspections".
3. When applicable, once a year the inspector samples for an Audit Test.

10.3 Test matrix - Fittings for mechanical joint

Table 16 – Test matrix – Fittings for mechanical joints

Description of requirements	Clause BRL	Tests within the scope of:	
		Pre-certification	Control after issue of the certificate ^{1), 2)}
Plastic fittings			
Classification	6.1	x	x
Material - general	6.2.1	x	x
Material - Plastics	6.2.2	x	x
Material - Copper and copper alloys	6.2.3	x	x
Appearance	6.3.1	x	x
Design	6.3.2	x	x
Colour	6.3.3	x	x
Geometric characteristics	6.4	x	x
MRS value	table 9	x	x
Effect of heating	table 9	x	x
Resistance to internal pressure	table 9	x	x ³⁾
MFR	table 9	x	x ³⁾
OIT (PE and PP)	table 9	x	x ³⁾
Metal fittings			
Compression fittings	table 10	x	x
Dimensions and design	table 10	x	x
Strength of the body	table 10	x	x
Resistance to stress corrosion	table 10	x	x
joint requirements plastic and metal fittings			
Leaktightness under internal water pressure	table 12	x	x ³⁾
Leaktightness under internal pressure of assemblies subjected to bending	table 12	x	x
Leaktightness under external hydrostatic pressure	table 12	x	x
Resistance to pull-out under constant longitudinal force	table 12	x	x ³⁾
Resistance to internal pressure	table 12	x	x ³⁾
Marking			
Marking	6.7	x	x

1. In case the product or production process changes significantly, the performance requirements shall be determined again.
2. During the inspection visit, the inspector shall check the product on the basis of a selection of the above listed requirements. The frequency of the inspection visits is recorded in clause 11,6 "Nature and frequency of external inspections".
3. When applicable, once a year the inspector samples for an Audit Test.

10.4 Test matrix - Fusion joints and fittings of PE

Table 17 – Test matrix – Fusion joints and fittings of PE

Description of requirements	Clause BRL	Tests within the scope of:	
		Pre-certification	Control after issue of the certificate ^{1), 2)}
Fittings			
weld ability	7.1	x	x
Material	7.2	x	x
Appearance	7.2	x	x
Design	7.2	x	x
Colour	7.2	x	x
Electrical characteristics for electrofusion fittings	7.2	x	x
Appearance of factory made joints	7.2	x	x
Dimensions	7.2	x	x
MFR	7.2	x	x ³⁾
OIT	7.2	x	x ³⁾
Marking	7.3	x	x
Joints			
Resistance to internal pressure	table 11	x	x ³⁾
Failure mode of butt-fused joint	table 11	x	x ³⁾
Decohesion test for PE electrofusion fitting	table 11	x	x ³⁾
Decohesion test for PE electrofusion saddle	table 11	x	x ³⁾

1. In case the product or production process changes significantly, the performance requirements shall be determined again.
2. During the inspection visit, the inspector shall check the product on the basis of a selection of the above listed requirements. The frequency of the inspection visits is recorded in clause 11,6 "Nature and frequency of external inspections.
3. When applicable, once a year the inspector samples for an Audit Test.

10.5 Inspection of the quality system

The quality system will be checked by Kiwa on the basis of the IQC scheme.

The inspection contains at least those aspects mentioned in the Kiwa Regulations for Product certification

11 Agreements on the implementation of certification

11.1 General

Beside the requirements included in these evaluation guidelines, the general rules for certification as included in the Kiwa Regulations for Product Certification also apply.

These rules are in particular:

- the general rules for conducting the pre-certification tests, in particular:
 - the way suppliers are to be informed about how an application is being handled;
 - how the test are conducted;
 - the decision to be taken as a result of the pre-certification tests.
- the general rules for conducting inspections and the aspects to be audited;
- the measures to be taken by Kiwa in case of Non-Conformities;
- the measures taken by Kiwa in case of improper use of Certificates, Certification Marks, Pictograms and Logos;
- terms for termination of the certificate;
- the possibility to lodge an appeal against decisions of measures taken by Kiwa.

11.2 Certification staff

The staff involved in the certification may be sub-divided into:

- Certification assessor (**CAS**): in charge of carrying out the pre-certification tests and assessing the inspectors' reports;
- Site assessor (**SAS**): in charge of carrying out external inspections at the supplier's works;
- Decision maker (**DM**): in charge of taking decisions in connection with the pre-certification tests carried out, continuing the certification in connection with the inspections carried out and taking decisions on the need to take corrective actions.

11.2.1 Qualification requirements

The qualification requirements are made up of:

- Qualification requirements for executive staff of a Certification body to comply with the NEN-EN-ISO/IEC 17065 requirements;
- Qualification requirements for executive staff of a CI certification established additionally by the Board of Experts for the subject of this BRL.

The competence of the certification personnel involved must be demonstrably recorded.

The Qualification requirements of certification staff is listed in table 18.

Table 18 – Qualification requirements of certification staff.

Basis requirements	Evaluation criteria
Knowledge of company processes Requirements for conducting professional audits on products, processes, services, installations, design and management systems.	<i>Relevant experience: in the field</i> SAS, CAS : 1 year DM : 5 years inclusive 1 year with respect to certification Relevant technical knowledge and experience on the level of: SAS : High school (MBO) CAS, DM : Bachelor (HBO)
Competence for execution of site assessments. Adequate communication skills (e.g. reports, presentation skills and interviewing technique).	SAS : Kiwa Audit training or similar and 4 site assessments including 1 autonomic under review.
Execution of initial examination	CAS : 3 initial audits under review.
Conducting review	CAS : conducting 3 reviews

	Certification assessor	Site assessor	Decision maker
Education - specific	<ul style="list-style-type: none"> • BRL-relevant technical education • specific studies and training (know-how and skills) 	<ul style="list-style-type: none"> • BRL-relevant technical education • specific studies and training (know-how and skills) 	<ul style="list-style-type: none"> • not applicable.
Experience - specific	<ul style="list-style-type: none"> • Detailed knowledge of the BRL and 4 certification tests carried out on the basis of the BRL or similar 	<ul style="list-style-type: none"> • Detailed knowledge of the BRL and 4 inspections carried out on the basis of the BRL or one similar. 	<ul style="list-style-type: none"> • general knowledge of the BRL

The level of education and experience of the certification staff involved should be demonstrably recorded.

Legend:

- Site assessor (**SAS**)
- Certification assessor (**CAS**)
- Decision maker (**DM**)

11.2.2 Qualification

The qualification of the certification staff shall be demonstrated by means of assessing the education and experience to the above mentioned requirements. The authority to qualify staff rests with the management of the certification body.

11.3 Report Pre-certification tests

The certification body records the results of the pre-certification tests in a report.

This report shall comply with the following requirements:

- completeness: the report provides a verdict about all requirements included in the evaluation guideline;
- traceability: the findings on which the verdicts have been based shall be recorded and traceable;
- basis for decision: the Decision maker shall be able to base his decision on the findings included in the report.

11.4 Decision for granting the certificate

The decision for granting the certificate shall be made by a qualified Decision maker which has not been involved in the pre-certification tests. The decision shall be recorded in a traceable manner.

11.5 Layout of quality declaration

The product certificate shall be in accordance with the model included in Annex I.

11.6 Nature and frequency of third party audits

The certification body shall carry out audits on site at the supplier at regular intervals to check whether the supplier complies with his obligations. The Board of Experts decides on the frequency of audits.

At the time this BRL entered into force, the frequency of audits amounts two audits on site per year for suppliers with a quality management system (in accordance with ISO 9001) for their production, which has been certified by an acknowledged body (in accordance with ISO/IEC 17021) and where the IQC scheme forms an integral part of the quality management system.

In case the production of the supplier is not certified against ISO 9001, the frequency of the audits on site may be increased to three per year.

The audit program on site shall cover at least:

- the product requirements;
- the production process at the place of manufacturing;
- the suppliers IQC scheme and the results obtained from inspections carried out by the supplier;
- the correct way of marking certified products;
- compliance with required procedures;
- handling complaints.

For suppliers with a private label certificate the frequency of audits amounts to two audit per two years. These audits are conducted at the site of the private label certificate holder. The audits are focussed on the aspects inserted in the IQC scheme and the results of the control performed by the private label holder with respect to at least

- the correct way of marking certified products;
- compliance with required procedures for receiving and final inspection;
- the storage of products and goods;
- handling complaints.

The results of each audit shall be recorded by Kiwa in a traceable manner in a report.

11.7 Report to the Board of Experts

The certification body shall report annually about the performed certification activities.

In this report the following aspects are included:

- mutations in number of issued certificates (granted/withdrawn);

- number of executed audits in relation to the required minimum;
- Results of the audits;
- Measures imposed by non-conformities;
- Received complaints from third parties about certified products.

11.8 Non conformities

When the certification requirements are not met, measures are taken by Kiwa in accordance with the sanctions policy what is published on the Kiwa service portal (www.kiwa.nl) in the corresponding BRL.

11.9 Interpretation of requirements

The Board of Experts may record the interpretation of requirements of this evaluation guideline in one separate interpretation document.

12 Titles of standards

12.1 Public regulation

Reference	Title
Staatscourant van 21 april 2017 nr. 20932	Regeling Materialen en Chemicaliën drink- en warm tapwatervoorziening

12.2 Standards / normative documents

Number ¹⁾	Title
BRL-K535	Beoordelingsrichtlijn voor het Kiwa productcertificaat voor glijmiddelen voor rubberring verbindingen
BRL-K17105	Evaluation guideline for the Kiwa product certificate for plastics piping systems of polyethylene for the transport of drinking water and raw water
BRL-K17504	Evaluation guideline for the Kiwa product certificate for vulcanised rubber products for cold and hot drinking water applications
iso 6964	Polyolefin pipes and fittings - Determination of carbon black content by calcination and pyrolysis - Test method and basic specification
iso 11922-1	Thermoplastics pipes for the conveyance of fluids - Dimensions and tolerances - Part 1: Metric series (ISO 11922-1:1997)
iso 13953	Polyethylene (PE) pipes and fittings - Determination of the tensile strength and failure mode of test pieces from a butt-fused joint
iso 13954	Plastics pipes and fittings - Peel decohesion test for polyethylene (PE) electrofusion assemblies of nominal outside diameter greater than or equal to 90 mm
iso 13955	Plastics pipes and fittings - Crushing decohesion test for polyethylene (PE) electrofusion assemblies
iso 13956	Plastics pipes and fittings - Decohesion test of polyethylene (PE) saddle fusion joints - Evaluation of ductility of fusion joint interface by tear test
nen 1006	Algemene voorschriften voor leidingwaterinstallaties (AVWI-2002)
nen 7200	Plastics pipelines for the transport of gas, drinking water and waste water - Buttwelding of PE pipes and fittings of PE 63, PE 80 and PE 100
nen-en 12099	Plastics piping systems - Polyethylene piping materials and components - Determination of volatile content
nen-en 12118	Plastics piping systems - Determination of moisture content in thermoplastics by coulometry
nen-en 12201-1	Plastics piping systems for water supply, and for drainage and sewerage under pressure - Polyethylene (PE) - Part 1: General
nen-en 12201-2	Plastics piping systems for water supply, and for drainage and sewerage under pressure - Polyethylene (PE) - Part 2: Pipes

nen-en 12201-3	Plastics piping systems for water supply, and for drainage and sewerage under pressure - Polyethylene (PE) - Part 3: Fittings
nen-en 12201-5	Plastics piping systems for water supply, and for drainage and sewerage under pressure - Polyethylene (PE) - Part 5: Fitness for purpose of the system
nen-en 1254-3	Copper and copper alloys - Plumbing fittings - Part 3: Fittings with compression ends for use with plastics pipes
nen-en 1716	Plastics piping systems - Polyethylene (PE) tapping tees - Test method for impact resistance of an assembled tapping tee
nen-en-iec 60335-1	Household and similar electrical appliances - Safety - Part 1: General requirements
nen-en-iso/iec 17020	Conformity assessment – General criteria for the operation of various types of bodies performing inspection
nen-en-iso/iec 17021-1	Conformity assessment – Requirements for bodies providing audit and certification of management systems
nen-en-iso/iec 17024	Conformity assessment – General requirements for bodies operating certification of persons
nen-en-iso/iec 17025	General requirements for the competence of testing and calibration laboratories
nen-en-iso/iec 17065	Conformity assessment - Requirements for bodies certifying products, processes and services
nen-en-iso 228-1	Pipe threads where pressure-tight joints are not made on the threads - Part 1: Dimensions, tolerances and designation
nen-en-iso 580	Plastics piping and ducting systems - Injection-moulded thermoplastics fittings - Methods for visually assessing the effects of heating
nen-en-iso 1133-1	Plastics – Determination of the melt mass-flow rate (MFR) and melt volume-flow rate (MVR) of thermoplastics – Part 1: Standard method
nen-en-iso 1167-1	Thermoplastics pipes, fittings and assemblies for the conveyance of fluids – Determination of the resistance to internal pressure – Part 1: General method
nen-en-iso 1167-2	Thermoplastics pipes, fittings and assemblies for the conveyance of fluids – Determination of the resistance to internal pressure – Part 2: Preparation of pipe test pieces
nen-en-iso 1167-3	Thermoplastics pipes, fittings and assemblies for the conveyance of fluids – Determination of the resistance to internal pressure – Part 3: Preparation of components
nen-en-iso 1183-1	Plastics – Methods for determining the density of non-cellular plastics – Part 1: Immersion method, liquid pycnometer method and titration method
nen-en-iso 2505	Thermoplastics pipes - Longitudinal reversion - Test method and parameters
nen-en-iso 3126	Plastics piping systems - Plastics components - Determination of dimensions
nen-en-iso 3459	Plastic piping systems - Mechanical joints between fittings and pressure pipes - Test method for leaktightness under negative pressure

nen-en-iso 3501	Plastics piping systems - Mechanical joints between fittings and pressure pipes - Test method for resistance to pull-out under constant longitudinal force
nen-en-iso 3503	Plastics piping systems - Mechanical joints between fittings and pressure pipes - Test method for leaktightness under internal pressure of assemblies subjected to bending
nen-en-iso 6259-1	Thermoplastics pipes - Determination of tensile properties - Part 1: General test method
nen-en-iso 6259-3	Thermoplastics pipes - Determination of tensile properties - Part 3: Polyolefin pipes
nen-en-iso 9080	Plastics piping and ducting systems - Determination of the long-term hydrostatic strength of thermoplastics materials in pipe form by extrapolation
nen-en-iso 11357-6	Plastics – Differential scanning calorimetry (DSC) – Part 6: Determination of oxidation induction time (isothermal OIT) and oxidation induction temperature (dynamic OIT)
nen-en-iso 15512	Plastics – Determination of water content
nen-iso 6957	Copper alloys - Ammonia tests for stress corrosion resistance
nen-iso 17885	Plastics piping systems - Mechanical fittings for pressure piping systems - Specifications
nen-iso 18553	Method for the assessment of the degree of pigment or carbon black dispersion in polyolefin pipes, fittings and compounds
npr-cen/ts 12201-7	Plastics piping systems for water supply, and for drainage and sewerage under pressure - Polyethylene (PE) - Part 7: Guidance for the assessment of conformity

1. The documents, in whole or in part, are normatively referenced in this document. For dated references, only the edition cited applies. For undated references, the latest edition of the reference document (including any amendments) applies.

Note: Within the text, references to specific divisions or subdivisions, tables and figures of another document shall always be dated.

II Model certificate

Certificaat	Productcertificaat KXXXXXX/OX	 Partner for progress
	Uitgegeven	
	Vervangt	
	Pagina	1 van 2
NAAM PRODUCT		
VERKLARING VAN KIWA Met dit, conform het Kiwa-Reglement voor Productcertificatie, afgegeven productcertificaat verklaart Kiwa dat het gerechtvaardigd vertrouwen bestaat dat de door		
NAAM LEVERANCIER		
geleverde producten, die zijn gespecificeerd in dit certificaat en voorzien van het onder "Merken" aangegeven Kiwa®-keur merk, bij aflevering voldoen aan Kiwa-beoordelingsrichtlijn BRL-K17105 "kunststof leidingsystemen van PE (Polyetheen) voor transport van drinkwater en ruw water".		
		
Bouke Meekma Kiwa		
Openbaarmaking van het certificaat is toegestaan.		
Advies: raadpleeg www.kiwa.nl om na te gaan of dit certificaat geldig is.		
Leverancier		
T F E I		
Certificatieproces bestaat uit initiële en periodieke beoordeling van: <ul style="list-style-type: none">• kwaliteitssysteem• product		

Kiwa Nederland B.V.
Sir Winston Churchilllaan 273
Postbus 70
2280 AB RIJSWIJK

Tel. 070 414 44 00
Fax 070 414 44 20
info@kiwa.nl
www.kiwa.nl



TECHNISCHE SPECIFICATIE

ONDERWERP

.....

MERKEN

.....

VERWERKING

PRESTATIES

WENKEN VOOR DE AFNEMER

Inspecteer bij aflevering of:

- geleverd is wat is overeengekomen;
- het merk en de wijze van merken juist zijn;
- de producten geen zichtbare gebreken vertonen als gevolg van transport en dergelijke.

Indien u op grond van het hiervoor gestelde tot afkeuring overgaat, neem dan contact op met:

- Naam van de certificaathouder

en zo nodig met:

- Kiwa Nederland B.V.

Raadpleeg voor de juiste wijze van opslag, transport en verwerking de verwerkingsvoorschriften van de certificaathouder.

* Voor de juiste versie van de vermelde documenten wordt verwezen naar het laatste wijzigingsblad bij BRL

III Model IQC scheme

Inspection subjects	Inspection aspects	Inspection method	Inspection frequency	Inspection registration
Raw materials or supplied materials, half products: <ul style="list-style-type: none"> • recipe sheets • Incoming goods inspection raw materials 				
Production process, production equipment, plant: <ul style="list-style-type: none"> • procedures • working instructions • equipment • plant 				
End products				
Measuring and testing equipment <ul style="list-style-type: none"> • measuring devices • calibration 				
Logistics <ul style="list-style-type: none"> • Internal transport • Storage • Preservation • Packaging • Identification or marking of semi-manufactures and end-products 				

IV Guidance for prevention of contamination during transport and storage of new products

(informative)

Importance of a hygienic operation

Hygiene and hygienic work is since decades an important issue with respect to the transport and distribution of drinking water in the Netherlands.

The impact of pollution can have big consequences for the water distribution¹⁾ and need substantial efforts to clean the system, especially because in the Netherlands chlorine is not used. Already in the 1983 published "guideline for installation of PVC-U piping systems, paragraph 4.2 "Storage", mentions this topic as follows: *For the prevention and risk of difficulties disinfecting of the pipe line afterwards, it is recommended to use plugs in pipe ends for storage of the pipes.*

The importance of hygiene also reflected in recent documents e.g. Dutch Hygiene code: "Hygiëncode Drinkwater; Opslag, transport en distributie" with the accompanying work instructions ("werkboekje") for mechanics. As result of the Hygiene code a wide range of courses for parties involved (installers, personnel of water companies, etc.) can be followed. Last but not least the Hygiene code is also mentioned in the drinking water law of July 1, 2011 and is therefore part of the Dutch law.

Protection of the products during storage and transport

In the "Hygiëncode Drinkwater: Opslag, transport en distributie" with the accompanying work instructions for mechanics the aspect how to work hygienically is extensively described. It involves dealing with parts for piping systems (pipes, fittings, valves and hydrants) starting with the arrival of the parts at the construction site to the realization and commissioning of the pipeline. The primary approach to hygienic work is "prevention". Secondly, there are measures described in order to make pipelines suitable for the delivery of clear drinking water. The hygiene aspects in the process from the manufacture of the product in the factory, assembly hall or other production location are briefly described in the "Hygiëncode Drinkwater". Also in this process is the primary approach prevention: For each product applies the sooner the product is protected against contamination²⁾, the better the hygiene of the product can be guaranteed. To close the hygiene chain completely and to be eligible for certification, producers of part for piping systems for drinking water shall have a procedure in which measures are described for storage and the route to the water companies (delivery address), as will be defined in general terms or laid down in relevant Kiwa evaluation guidelines. The producer shall have a procedure for the protection of the products during transport and storages, to be able to guarantee that hygiene requirements are meet.

Note:

- 1) Mostly this is a microbiological contamination coming from the surrounding area on macro- and micro scale like dust, but also faeces and dead beasts.
- 2) In this context the word "protection" is used as a combination of packing (e.g. providing the product with a casing) and, when applicable, providing end caps (e.g. for pipes and fittings).

Requirements for the protection

For all preventive (protective) actions taken to protect the products against pollution, it is important that the protection is sufficient during the complete process starting after

production of the product (followed by e.g. storage, transport and again storage) and ending with the installation of the products.

Capabilities to protect the product:

The used packaging depends on the product itself (shape, dimensions, etc.)

Some packaging solutions (not binding and not exhaustive) are mentioned below:

- For small fittings (couplings, rings, rubber seals) a plastic bag eventually in a box;
- "Bubble wrap" foil in combination with adhesive tape for all openings for big(ger) fittings;
- The combination of bags made of fiber reinforced material or heat shrink foil and the use of a box for smaller part;
- End-caps / plugs or stern plastics bags for the pipe ends (where the complete pipe package is wrapped in foil).

In 2007 representatives of the manufacturers and the water companies organized in the commission 'OnderhandelingsCommissie Kunststoffen' (OCK) started a project to improve the quality of packaging.

The project resulted in the following construction of end-capes for pipes.

The end cap is unmovable fixed in the pipe by using flaps in a labyrinth structure to let in air but prevent pollution.

The end cap is developed for a 110 mm PVC pipe but can also be developed for other diameters (50, 63, 75, 90, 160, 200 and 250 mm), and for all used pipe materials.

For closing pipe ends with a diameter of 315, 400, 500 and 630 mm a fiber reinforced cover in combination with adhesive tape or lashing straps can be used (see the pictures below).

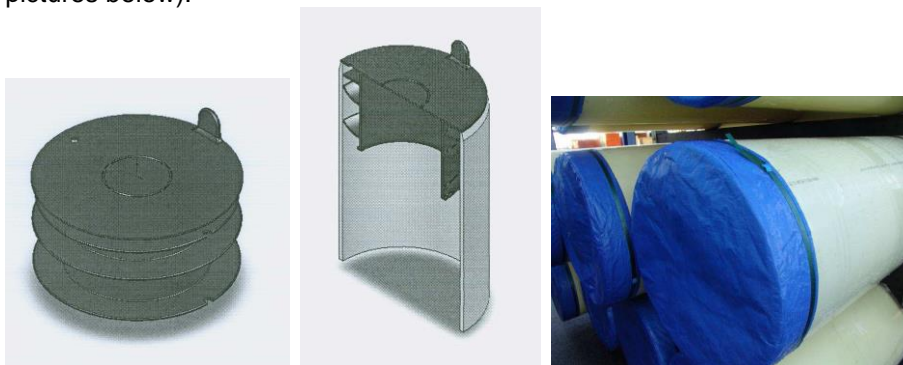

Left: end cap with flaps. Right: fiber reinforced cover in combination with adhesive tape.

Mess bags cannot be sealed against dust and dirt, and for this reason are not recommended as the only packaging for small parts.